



iColor® 700 Digital Label Press

User Manual



June 2017 Revision - A newer version of this manual may be available at www.icolorprint.com/support

UniNet 3232 W. El Segundo Blvd., Hawthorne, California 90250 | sales@icolorprint.com
www.icolorprint.com

Table of Contents

1	GENERAL INFORMATION.....	4
1.1	SAFETY INFORMATION.....	5
1.2	SYSTEM SPECIFICATIONS.....	6
1.3	ROLL SPECIFICATIONS.....	7
1.4	ICOLOR 700 FRONT VIEW.....	9
1.5	ICOLOR 700 REAR VIEW.....	10
1.6	ICOLOR 700 INTERNAL FEEDER VIEW.....	11
1.7	ICOLOR 700 REWINDER VIEW.....	12
1.8	FEEDER DISPLAY MENU FUNCTIONS.....	13
1.9	PRINTER OPERATOR PANEL.....	15
2	FIRST TIME SETUP.....	16
2.1	UNPACKING AND SETTING UP THE PRINTER.....	16
2.2	HOW TO GET THE SOFTWARE INSTALLATION FILES.....	22
2.3	CHANGE USER ACCOUNT CONTROL SETTINGS.....	22
2.4	CHANGE REGION FORMAT.....	24
2.5	HOW TO INSTALL RIP.....	25
2.6	HOW TO INSTALL EDGE2PRINT.....	27
2.7	SETTING UP THE IP ADDRESSES.....	29
2.7.1	<i>Setting up the IP Address on the Printer.....</i>	<i>29</i>
2.7.2	<i>Setting up the IP Address on the Feeder.....</i>	<i>33</i>
3	BEFORE PRINTING.....	37
3.1	EDGE2PRINT USER INTERFACE.....	37
3.2	INPUT IP ADDRESSES INTO EDGE2PRINT.....	38
3.3	CHANGING THE COLOR REGISTRATION.....	40
3.4	SETTING UP THE COST ESTIMATION CALCULATOR.....	41
3.5	CHANGING UNITS OF MEASUREMENT.....	42
3.6	CHANGING BORDERS ON PDF PREVIEW.....	43
3.7	MEASURING YOUR MEDIA.....	44
3.8	LOADING MEDIA FOR CONTINUOUS PRINTING.....	47
3.9	SENSOR CALIBRATION FOR DIE-CUT LABEL PRINTING.....	53
4	PRINTING.....	55
4.1	SELECTING A MEDIA ID.....	55
4.2	HOW TO CREATE A NEW MEDIA ID.....	56
4.3	EDITING A NEWLY CREATED MEDIA ID.....	58
4.4	ADDING LABEL IMAGES TO PRINT.....	59
4.5	ADJUSTING THE PRINT ALIGNMENT.....	61
4.6	NESTING.....	63
4.7	HOW TO ACTIVATE VARIABLE DATA (iVDP).....	65
4.8	PRINTING VARIABLE DATA.....	66
4.9	PRINTING USING BANNER MODE.....	68
4.10	HOW TO ACTIVATE WHITE TONER.....	71
4.11	PRINTING USING WHITE TONER.....	73
4.12	HOW TO SET UP THE REWINDER.....	76
5	SOFTWARE FEATURES AND OPTIONS.....	80
5.1	HOW TO PRINT A FULL BLEED DIE CUT LABEL.....	80
5.2	INSTALL YOUR OWN ICC PROFILE.....	82
5.3	RIP SETTINGS.....	85
5.4	INSTALLING THE FONTS IN THE RIP.....	86
5.5	RIP ROTATE OPTIONS.....	90
5.6	RIP SCALING OPTIONS.....	91

5.7	BOUNDING BOX OPTION.....	92
5.8	SAVING AND LOADING PAGE INFORMATION	94
5.9	HOW TO VIEW COST ESTIMATION REPORT.....	95
5.10	REPRINT OPTION.....	97
5.11	WARNING OPTIONS	98
5.11.1	<i>Consumable Warning</i>	98
5.11.2	<i>Fuser Warning</i>	99
5.12	WHITE TONER WARNING.....	100
6	TROUBLE SHOOTING AND MAINTENANCE	101
6.1	TONER CARTRIDGE REPLACEMENT.....	103
6.2	IMAGE DRUM REPLACEMENT	103
6.3	REPLACING THE TRANSFER BELT UNIT	105
6.4	FUSER REPLACEMENT	107
6.5	CLEARING PAPER JAMS	109
6.6	HOW TO PRINT CONFIGURATION INFORMATION FROM THE PRINTER	113
6.7	HOW TO PRINT A SECURE JOB FROM THE PRINTER	113
6.8	SENSOR CALIBRATION FROM THE FEEDER (FOR DIE CUT LABELS ONLY).....	114
6.9	HOW TO ACCESS THE SETTINGS AS AN ADMINISTRATOR.....	119
6.10	PAPER SENSOR ERROR CODES	120

Please ensure you follow every step in order.

If your system does not comply with this list, DO NOT continue the install!

Overview of the Installation

System Requirements

- Optimal Requirement (CPU, Memory, HDD and SO)
 - Processor: i7 3.5GHz 4770K or better
 - Hard Drive: SSDs with 500MBs or greater
 - Memory: 12 GB DDR3 1666MHz or greater.
 - Motherboard: x79 Chip
 - Windows 7 pro and Windows 10 64 bit only

- Minimum Requirement for software WITHOUT variable data (CPU, Memory, HDD and SO)
 - Processor: Intel i5
 - Hard Drive: 7200 RPM
 - Memory: 8 GB
 - Windows 7 Pro and Windows 10 64 bit only

- Power 120v and 220v
 - Minimum outlets (5)

- Network
 - (2) IP Addresses for the Feeder and Printer
 - (3) Network Cables

Before starting the software installation, you need to ensure that you have a **clean version** of Windows 7 or 10 with nothing installed. In order to do so, you will need to make sure of the following:

- There are no applications installed or currently running.**
- There are no antivirus programs installed.**
- The computer you're planning to install the software on has the printer and feeder on the same network.**
- Ensure your user account has Administrator privileges on the local computer.**

1.1 Safety Information

Your UniNet product has been carefully designed to give you years of safe, reliable performance. As with all electrical equipment, there are a few basic precautions you should take to avoid hurting yourself or damaging the product.

Warning - Here are some of the things to look for:

- Save all provided documentation for future reference. Ensure all warning and instruction labels on the product are read, understood and followed in order to prevent any risk of injury.
- This product may be heavy. Please check the weight of the product and take all necessary precautions to prevent the risk of personal injury. Place your product on a firm, solid surface. If placed on something unsteady, it may fall and be damaged. If placed on a soft surface, the vents may be blocked, causing the product to overheat.
- If the product is installed on a cabinet or high capacity feeder, ensure wheel locks are applied once placed in final position for use, to prevent risk of movement or injury.
- Protect your product from overheating. Make sure no obstructions block the openings of the product. Do not put the product on or near a heat source (such as a radiator or heat register). Keep the product out of direct sunlight. Allow enough room around the product for adequate ventilation and easy access to the paper paths. If the product is placed in any kind of enclosure, make sure the enclosure is well ventilated to prevent a fire.
- When the product cover is open, do not touch the fuser unit or print head as you may receive burns. Allow it to cool before touching.
- If the product casing gets extremely hot or smoke, unusual smells or abnormal noises are emitted from the product, there is a risk of fire. Unplug the mains connector and contact UniNet service.
- Do not use the product near water. Do not spill liquid of any kind on it. Do not connect or disconnect the power plug with a wet hand as this may cause electric shock. Unplug the product before you clean it. Use only a damp cloth; do not use liquid or aerosol cleaners. Do not use an extremely flammable spray near the product as the product contains high temperature parts that may cause a fire.
- Be certain that your power source matches the rating listed on the back of the product. If you are not sure, check with your dealer or local power company before connecting the product.
- Do not connect this product to an uninterruptible power supply (UPS).
- Your product has a grounded, three-prong plug as a safety feature. This plug only fits into a grounded outlet. If the plug does not fit, the outlet may be an older, non-grounded type. Contact an electrician to have the outlet replaced. Do not use an adapter to defeat the grounding.
- Install the product near an easily accessible power outlet and avoid damaging the power cord. Do not put anything on it or place it where it will be walked on. If the cord becomes damaged or frayed, replace it immediately.
- If you are using an extension cord or power bar with the product, make sure the total amperes required by all the equipment on the extension is less than the extension's rating. The total ratings of all equipment plugged into the outlet should not exceed 15 amperes.
- Do not poke anything in the ventilation slots of the product. You could get an electrical shock or cause hazardous electrical arcing, which could cause a fire.
- The acoustic noise of this product is less than 70 dB (A) as measured in accordance with EN ISO 7779.
- The operating condition range for your product is: 10 to 32°C and 20 to 80% RH. Operation of the product outside this range could result in damage to the product.
- Do not throw toner cartridges or image drum cartridges into a fire as you may receive burns from a dust explosion.
- Ensure loose clothing and hair is kept clear of moving parts when the product is in operation to prevent possible risk of injury.
- Ensure both the product and mains power switches are in the OFF position before connecting the AC power cable.
- Always hold the power plug to connect/disconnect the power cable to/from the mains socket. Unplugging by pulling on the cable can cause fraying and may lead to fire or electric shock.
- Use only the power cable supplied. Using a power cable not intended for this product may lead to fire or electric shock. Do not use the power cable supplied with this product for any other electrical equipment.
- Aside from the routine maintenance described in the documentation, do not try to service the product yourself. Removing the cover may expose you to shocks or other hazards.
- Do not make any adjustments other than those outlined in the documentation. You may cause damage that will require extensive repair work. The provided documentation explains how to get your product serviced by qualified UniNet technicians. If anything happens that indicating your product is not working properly or has been damaged, unplug it immediately and follow the procedures in the provided documentation for having your product serviced.

1.2 System Specifications

iColor 700: System Specifications	
Print Speed	Up to 9.14 meters/min (30 ft/min)
Technology	Single Pass 4 Color LED (CMYK)
Printer Processor¹	533 MHz
Media Width	Minimum: 6.0 inches (152.4 mm) Maximum: 8.5 inches (216 mm)
Print Width	Minimum: 6.0 inches (152.4 mm) Maximum: 8.24 inches (209.3 mm)
Print Length	Up to 420 meters (1378 ft)
Substrate Types²	Die Cut Label Stock Kiss Cut Label Stock Non Die Cut Label Stock Tag Stock
Print Quality	1200 x 600 dpi
Toner Supplies³	CMY - 11,500 pages @ 5% K - 11,000 pages @ 5% (Rated according to ISO/IEC 19798 guidelines)
Drum Supplies⁴	CMYK - 30,000 pages @ 5% (Rated according to ISO/IEC 19798 guidelines)
Feeder System	Input roll maximum outside diameter: 8 inches (203 mm) Core inside diameter: 3 inches (76.2 mm) Maximum input roll weight: 14 lbs (6.35 kg) Cut on the fly, auto cut Auto page width registration Front Panel LCD interface Web management system torque Auto adjusting form synchronization
Rewinder System	Output roll maximum diameter: 8 inches (203 mm) Core inside diameter: 3.0 inches (76.2 mm) Maximum output roll weight: 14 lbs (6.35 kg)
Dimensions (H X W X D)	Printer & Feeder: 26" x 17.1" x 21.5" (660 mm x 434 mm x 546 mm) Rewinder: 16" x 19.75" x 19" (406 mm x 502 mm x 483 mm)
Weight	Printer & Feeder: 110 lbs (49.9 kg) Rewinder: 27.65 lbs (12.54 kg)
Operating Environment	Temperature: 10°C to 20°C (50 to 89.6°F) Humidity: 20 to 60% RH
Power	110 - 127 VAC, 50/60 Hz @ 1150W 220 - 240 VAC, 50/60 Hz @ 1150W
Certifications	FCC Class A, CE, cTUVus, CCC
Warranty	1 year – Parts & Labour
<p>1. Published performance results based on laboratory testing. Individual results may vary.</p> <p>2. This product is designed and engineered to operate only with genuine UniNet consumables and certified media substrates. Please contact UniNet for the most current Certified Media List of substrates available.</p> <p>3. Letter-size sheets at 5% coverage. Printer ships with a 7,500 page set of starter toners.</p> <p>4. Based on 500 cut-sheet pages/job.</p> <p>UniNet reserves the right to change product specifications without notice. Trademarks are the property of their respective manufacturers. ©2014 Copyright, UniNet. All Rights Reserved. All content is subject to change without notice.</p>	

1.3 Roll Specifications

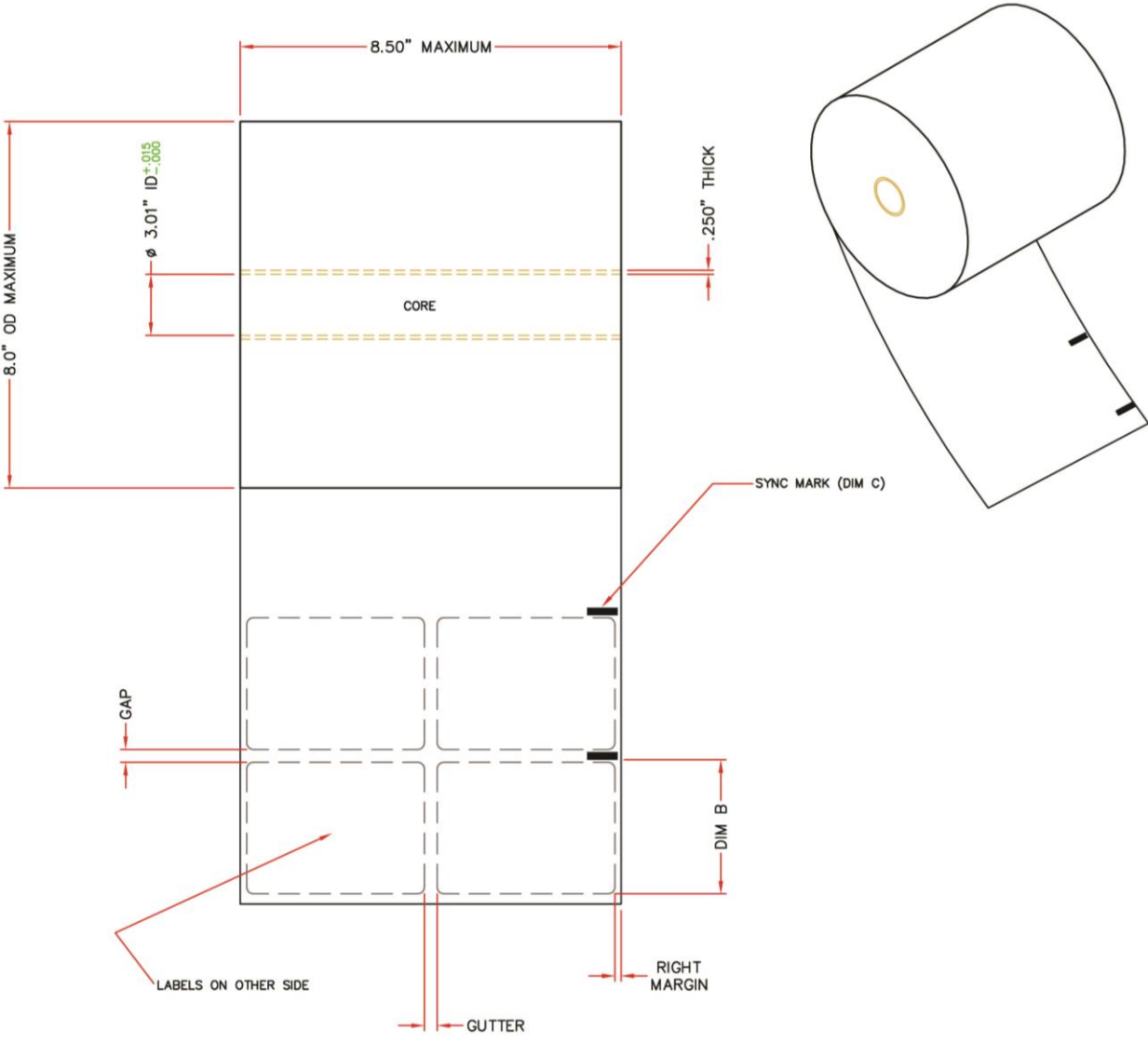

Packaging Notes

- 1.) Core plugs must be used
- 2.) Roll edges must be fully supported to prevent damage to the roll during shipping
- 3.) Media roll must be protected from moisture absorption

Roll Notes

- 1.) Image side wound out
- 2.) Core:
 - a.) Inside diameter = 3.01" – 3.025"
 - b.) Thickness = 0.250"
- 3.) Core must be flush or inset < 1/16" at each end
- 4.) Core must be attached to the label material using either double sided releasable tape or low tack glue
- 5.) Leading edge must be square and clean
- 6.) Roll coning is not allowed
- 7.) Splicing is not allowed
- 8.) Glue ooze is not allowed
- 9.) Roll outside diameter = 8.0" maximum
- 10.) Roll weight = 30lbs maximum

Non Die Cut Label Notes

- 1.) No sync marks needed

Die Cut Label Notes:

- 1.) Can use either gap sensor or sync mark (see limitations below)
- 2.) Left & Right Margins:
 - a. Using gap sensor = 0.063" maximum
 - b. Using sync mark = No Limit
- 3.) Label gap & gutter spacing 0.125" minimum
- 4.) Label corner radius
 - a. Using edge sensor = 0.125" maximum
 - b. Using sync mark = no limit (ie. Circles)

Kiss Cut Label Notes

- 1.) Must use sync mark
- 2.) Left & right margins 0.063" minimum
- 3.) Label gap & gutter spacing 0.125" minimum
- 4.) Label corner radius
 - a. Using sync mark = No Limit**Note:** Cannot use gap sense method

Sync Mark Notes:

- 1.) Each label row is to be marked with a sync mark
- 2.) Sync mark the right edge of the label material as it unwinds
- 3.) Sync mark using a black i-mark
 - a. DIM C = 0.125" wide x 0.5" long
 - b. Offset from edge = 0.030"
- 4.) Sync marks are to be accurately placed between each tag or label in the gap area
 - a. DIM B – TBD (Depends on the size of the tag or label)
- 5.) Sync mark density:
 - a. 1.2 ortho (matte black finish)

1.4 iColor 700 Front View

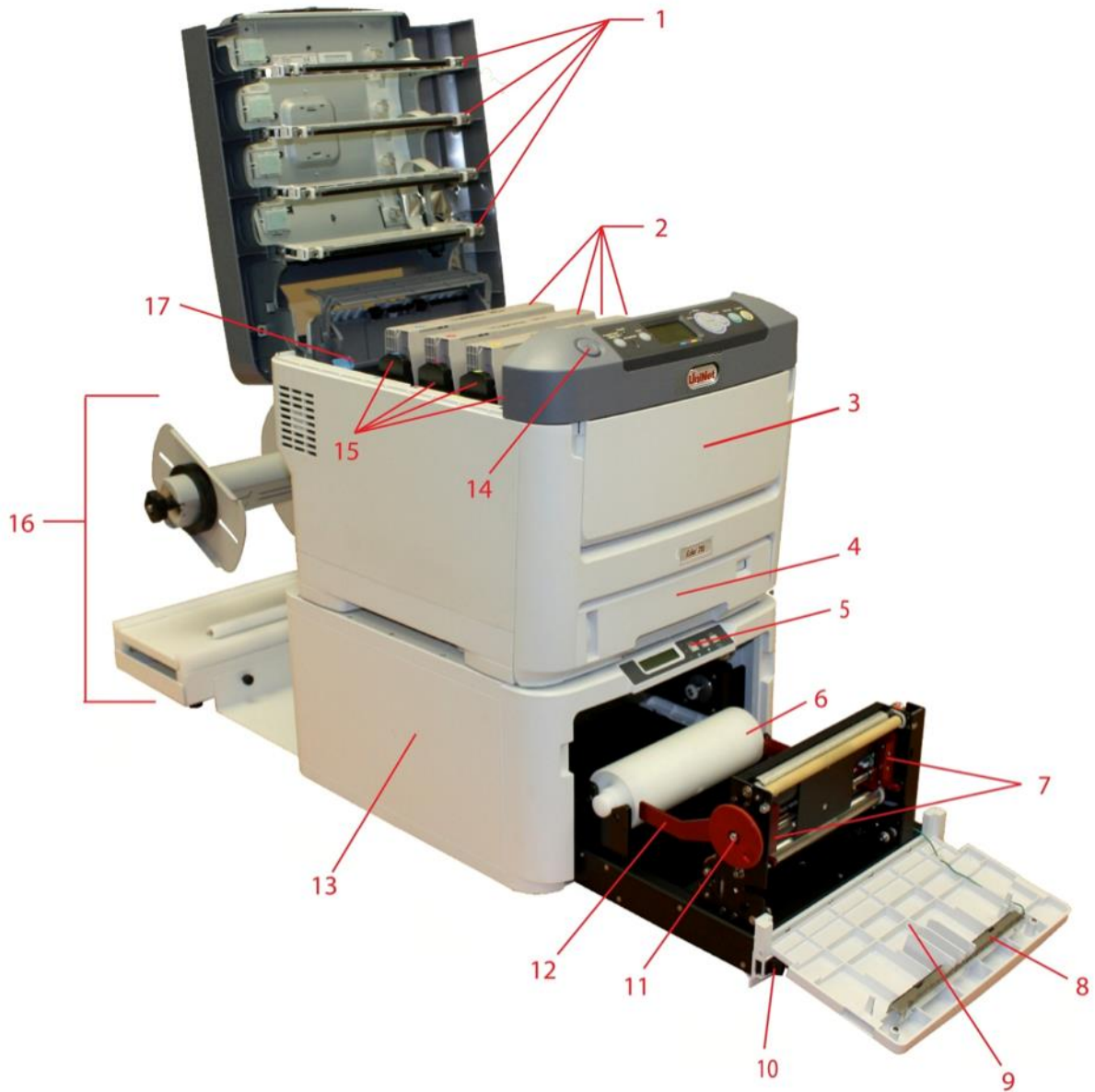

1. LED Heads	10. Black Tray Latches
2. Toner Cartridges (C, M, Y, K)	11. Width Adjustment Wheel
3. Front Cover Release Lever (Blue Handle Behind Cover)	12. Extension Arms
4. Cut On The Fly Module	13. Feeder
5. Feeder Display Menu	14. Top Cover Release Button
6. Spindle Pin	15. Drum Units (C, M, Y, K)
7. Left and Right Media Guides	16. Rewinder
8. Static Bar	17. Fuser Release Levers
9. Front Cover	

1.5 iColor 700 Rear View

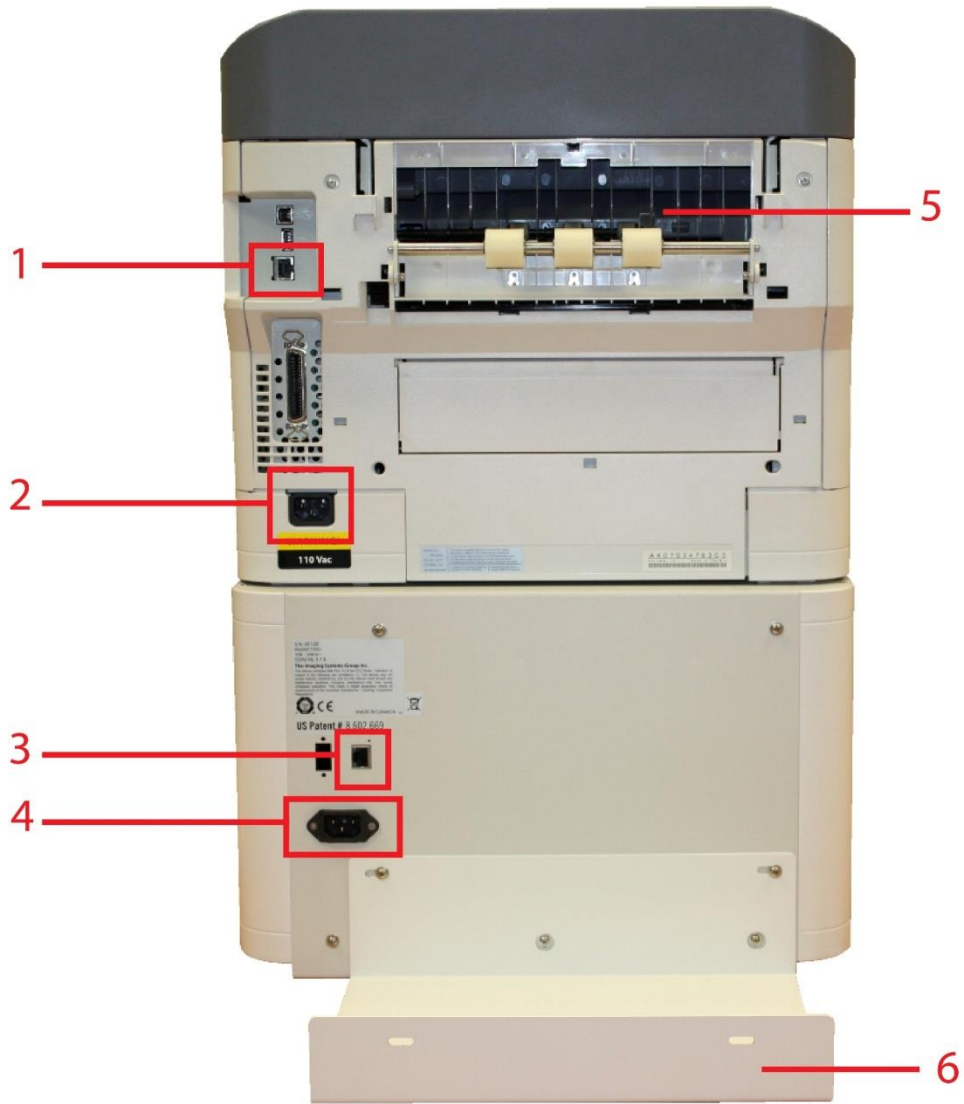

1. Printer Network Connection
2. Printer Power Outlet
3. Feeder Network Connection
4. Feeder Power Outlet
5. Paper Exit Path
6. Rewinder Plate (Rewinder Not Shown Attached)

Note: USB port is not available

1.6 iColor 700 Internal Feeder View

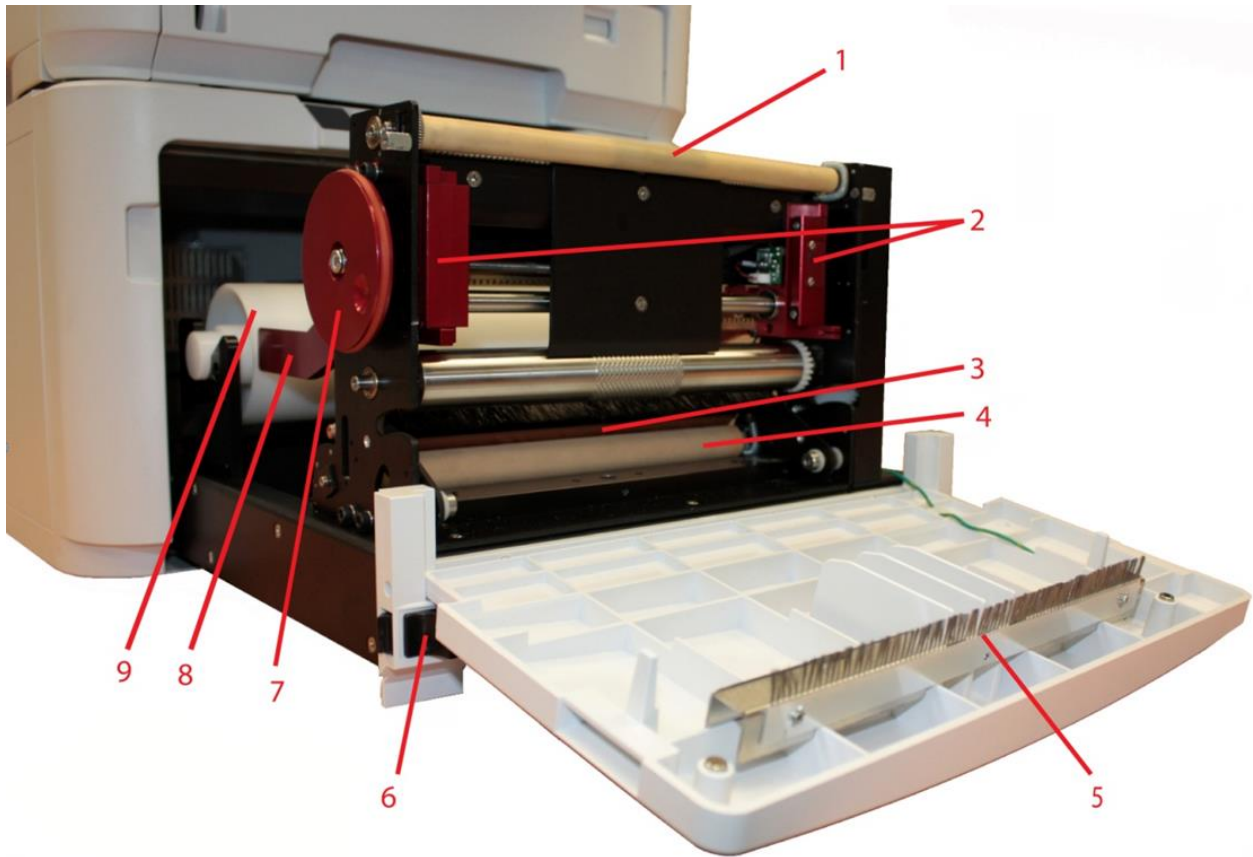

1. Drive Roller
2. Left and Right Media Guides
3. Tension Roller
4. Pinch Roller
5. Static Bar
6. Black Tray Latches
7. Width Adjustment Wheel
8. Extension Arms
9. Spindle Pin

1.7 iColor 700 Rewinder View

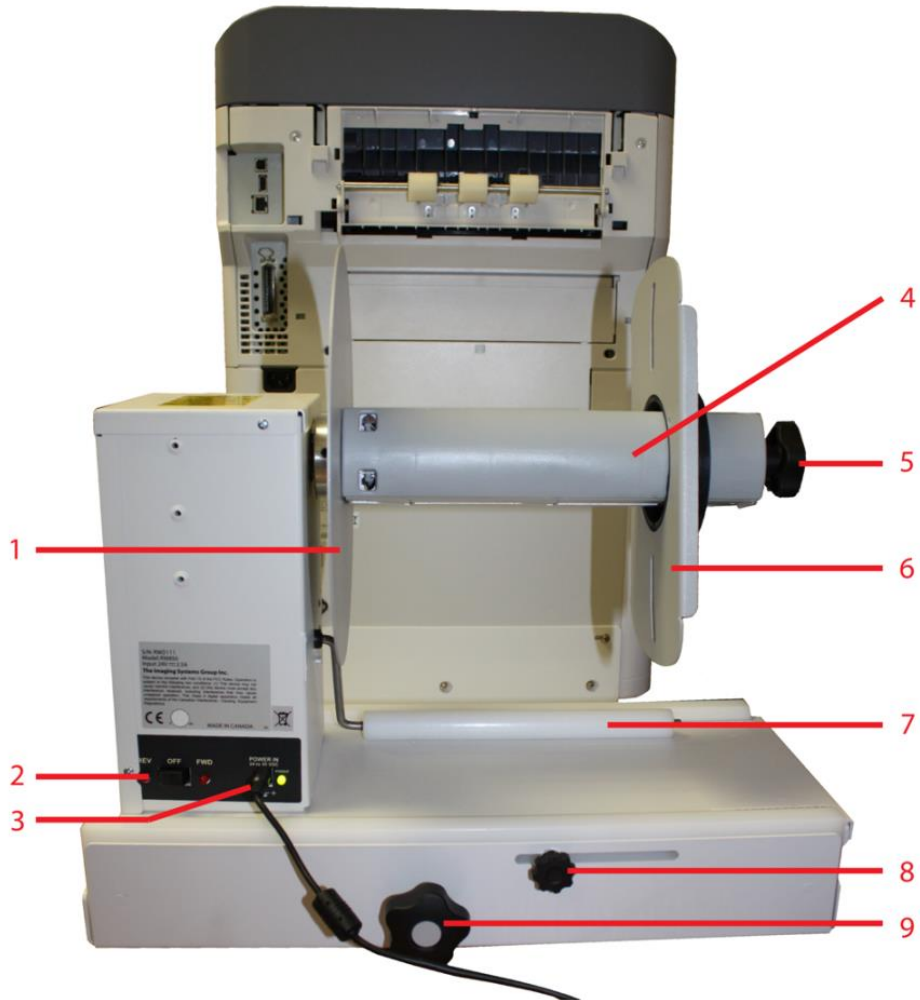

1. Left End Disk
2. Switch Panel
3. DC Power In
4. Spindle
5. Core Adjustment Knob
6. Right End Disk
7. Dancer Arm
8. Lockdown Knob
9. Width Adjustment

1.8 Feeder Display Menu Functions

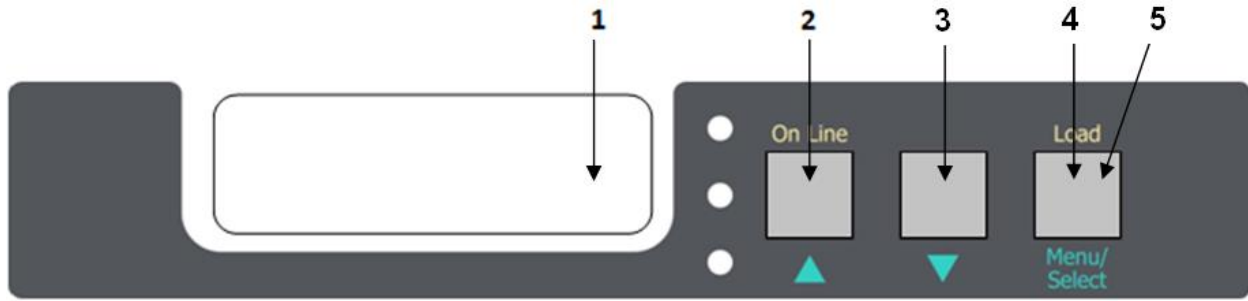

1. **Display** – Displays the feeder status and any error messages
2. **On Line/UP** – Toggles between Online and Offline, and also serves as an “UP” selection button
3. **DOWN** – Serves as an “DOWN” selection button
4. **Load Button** – Press to complete loading paper
5. **Menu/Select** - Accesses the three menus: Feeder Configuration, Feeder Calibration and Network Settings

To access the feeder menu items, press the **On Line** button to toggle online or offline and gain access to your Menu system. There are three main menu items: **Feeder Configurations**, **Feeder Calibrations** and **Network Settings**.

M1: Feeder Configurations – NOT AVAILABLE	
To access the feeder configuration menu, select On Line to turn the feeder offline. Press the Menu key once for the M1: Feeder Config menu to appear. The following item is under Feeder Config:	
I1: Media Type	To access the I1: Media Type menu, select the On Line button to take the feeder offline. To change the media type, hold down the Menu key until the * disappears. Use the UP and DOWN arrow keys to select the required media. To save the selection, hold down the Menu key again until the * appears. The media type is now set. To exit press the Menu button. Select On Line button to take the feeder back online.

M2: Calibrations	
Under the Calibrations menu items, it is possible to configure both the Top and Bottom Load Sensors, the Sensor Gap, Cut on the Fly parameters and Auto Calibration menus.	
To access the M2: Calibrations menu, select On Line to turn the feeder offline. Press the Menu key twice for the M2: Calibrations menu to appear. The following items are under Calibrations:	
I1: Bot Load Sensor	This item configures the parameters for the bottom load sensor. To access the I1: Bot Load Sensor menu, select the UP arrow until I1: Bot Load Sensor is shown on the display. To change the settings, hold down the Menu key for about one full second until the * disappears. Use the UP and DOWN arrow keys to set the required values. To save the values, press Menu . When all values have been set, press and hold the Menu key for about one full second, until the * appears. The bottom load sensor values are now set. To exit press the Menu button. Select On Line button to take the feeder back online.
I2: Top Load Sensor	This item configures the parameters for the top load sensor. To access the I2: Top Load Sensor menu, select the UP arrow until I2: Top Load Sensor is shown on the display. To change the settings, hold down the Menu key for about one full second until the * disappears. Use the UP and DOWN arrow keys to set the required values. To save the values, press Menu . When all values have been set, press and hold the Menu key for about one full second, until the * appears. The top load sensor values are now set. To exit press the Menu button. Select On Line button to take the feeder back online.

I3: Reg Sensor Back	<p>This item configures the gap between back sensors. To access the I3: Reg Sensor Back menu, select the UP arrow until I3: Reg Sensor Back is shown on the display.</p> <p>To change the settings, hold down the Menu key for about one full second until the * disappears. Use the UP and DOWN arrow keys to set the required values. To save the values, press Menu. When all values have been set, press and hold the Menu key for about one full second, until the * appears. The back sensor or gap values are now set. To exit press the Menu button. Select On Line button to take the feeder back online.</p>
I4: RSEN Autocal	<p>This item configures the auto calibration values. To access the I4: RSEN Autocal menu, select the UP arrow until I4: RSEN Autocal is shown on the display.</p> <p>To change the settings, hold down the Menu key for about one full second until the * disappears. Use the UP and DOWN arrow keys to set the required values. To save the values, press Menu. When all values have been set, press and hold the Menu key for about one full second, until the * appears. The autocalibration values are now set. To exit press the Menu button. Select On Line button to take the feeder back online.</p>
I5: COTF Parameters	<p>This item configures the parameters for Cut on the Fly. To access the I5: COTF Parameters menu, select the UP arrow until I5: COTF Parameters is shown on the display.</p> <p>To change the settings, hold down the Menu key for about one full second until the * disappears. Use the UP and DOWN arrow keys to set the required values. To save the values, press Menu. When all values have been set, press and hold the Menu key for about one full second, until the * appears. The COTF parameter values are now set. To exit press the Menu button. Select On Line button to take the feeder back online.</p>

M3: Network Settings	
<p>The Network Settings menu items allow configuration of the IP Address, the Subnet Mask and the Default Gateway.</p> <p>To access the M3: Network Settings menu, select On Line to turn the feeder offline. Press the Menu key three times for the M3: Network Settings menu to appear. The following items are under Network Settings:</p>	
I1: IP Address	<p>This item sets the IP Address. To access the I1: IP Address menu, select the UP arrow until I1: IP Address is shown on the display.</p> <p>To change the settings, hold down the Menu key for about one full second until the * disappears. Use the UP and DOWN arrow keys to set the required values. To save the values, press Menu. When all values have been set, press and hold the Menu key for about one full second, until the * appears. The IP Address now set. To exit press the Menu button. Select On Line button to take the feeder back online.</p>
I2: Subnet Mask	<p>This item sets the Subnet Mask. To access the I2: Subnet Mask menu, select the UP arrow until I2: Subnet Mask is shown on the display.</p> <p>To change the settings, hold down the Menu key for about one full second until the * disappears. Use the UP and DOWN arrow keys to set the required values. To save the values, press Menu. When all values have been set, press and hold the Menu key for about one full second, until the * appears. The Subnet Mask is now set. To exit press the Menu button. Select On Line button to take the feeder back online.</p>
I3: Gateway	<p>This item sets the Default Gateway. To access the I3: Gateway menu, select the UP arrow until I3: Gateway is shown on the display.</p> <p>To change the settings, hold down the Menu key for about one full second until the * disappears. Use the UP and DOWN arrow keys to set the required values. To save the values, press Menu. When all values have been set, press and hold the Menu key for about one full second, until the * appears. The default Gateway now set. To exit press the Menu button. Select On Line button to take the feeder back online.</p>

1.9 Printer Operator Panel

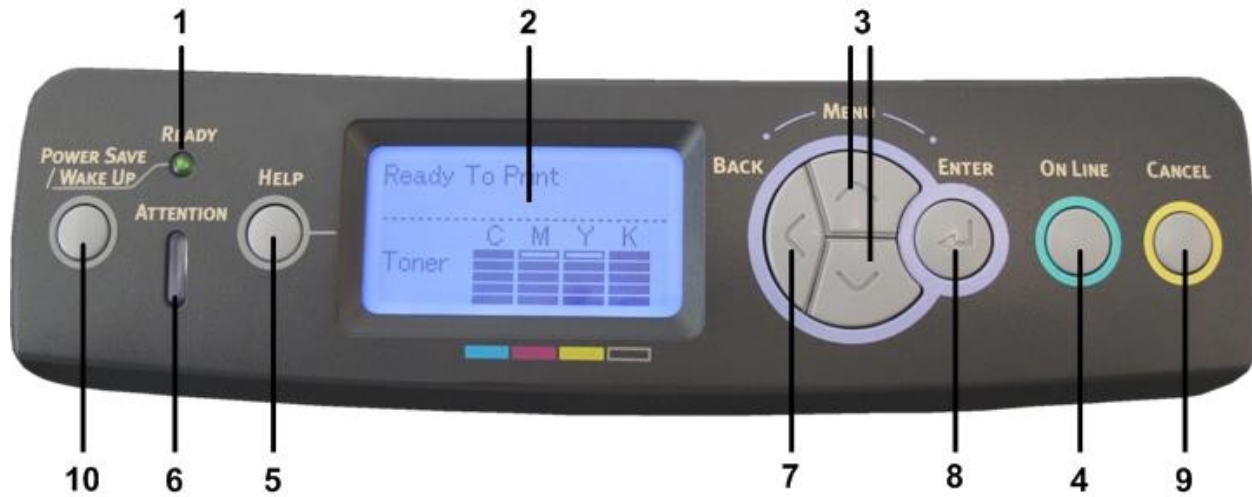

1. Ready LED	ON: Ready to receive data BLINKING: Processing data OFF: Offline	6. Attention LED	ON: A warning occurs. Printing may be possible (e.g. low toner) BLINKING: An error occurs. Printing not possible (e.g. toner empty) OFF: Normal Condition
2. Display	Displays the printer status and any error messages.	7. Back Button	Returns to the previous menu
3. Menu Scroll Buttons	Enters the Menu mode. In Menu mode, forwards or reverses the menu item displayed. Press for 2 seconds or longer to jump from top to bottom	8. Enter Button	In the ONLINE or OFFLINE mode: enters the Menu mode. In the Menu mode: determines the setting selected.
4. On Line Button	Switches between ONLINE and OFFLINE Scrolls the HELP screen	9. Cancel Button	Deletes the data being printed or received when pressed for two seconds or longer. Exits the menu and goes ONLINE when pressed in the Menu mode.
5. Help Button	Provides advice when an error occurs	10. Power Save/ Wake up Button	Pressing this button switches the machine into sleep or wake-up mode.

2 First Time Setup

2.1 Unpacking and Setting Up the Printer

STEP 1 of 11



With two people lift the top (feeder) box off of the bottom (printer) box. Open the feeder box and remove the feeder.

Remove the wing nut on the bottom of the feeder before placing upright on any surface. Position the feeder on a level surface. Open the feeder and remove all packaging material. Close the feeder door.

STEP 2 of 11



Lift the lid off of the printer box. With two people, remove the printer from the box. Remove all of the packaging tape from the outside of the printer.

STEP 3 of 11



Press the button to open the top lid.

STEP 4 of 11



Remove the fuser shipping lock.

STEP 5 of 11



Pull the drums/toners out of the printer. Remove the protective film. Place the drums and toners back into the printer. Ensure all four toners are locked into the four drums by checking the blue lever. Close the printer lid.

IMPORTANT: Once the drums/toners are removed, they must not be exposed to light for more than 5 minutes. To prevent damage, cover them with a dark sheet or reinstall.

NOTE: All consumables are print ready and do not need to be replaced upon opening. Once the consumables have reached their lifespan, please refer to the appendix on how to replace and install all consumables

STEP 6 of 11



Align the printer with the pins located on the top of the feeder. Keep the printer level and flush to the front while lowering it onto the feeder.

STEP 7 of 11



Unpack the rewriter, removing all of the packaging tape.

Unwrap the rewriter attachment and prepare to install on the printer.

STEP 8 of 11

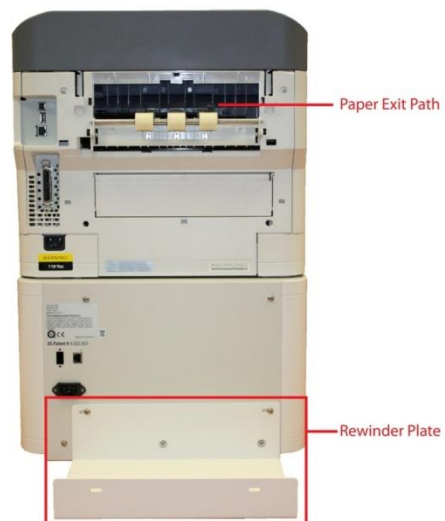

Attach the rewriter plate to the feeder using the screws located on the back of the feeder. Make sure it is in line with the paper output feeder. You can adjust the rewriter plate once it is loosely secured by moving it slightly left or right. Adjust accordingly.

STEP 9 of 11

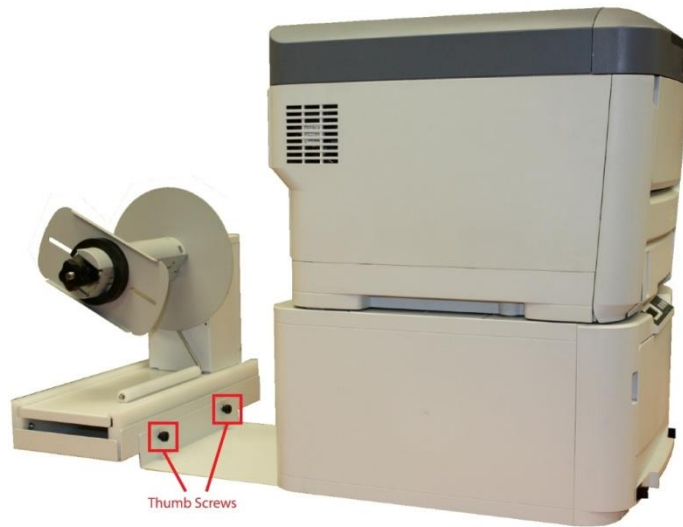

Attach the rewriter mechanism to the plate using the black thumbscrews. Make sure that the rewriter mechanism is fully supported so it does not bend or break the rewriter plate. The rewriter attachment has been successfully installed.

STEP 10 of 11

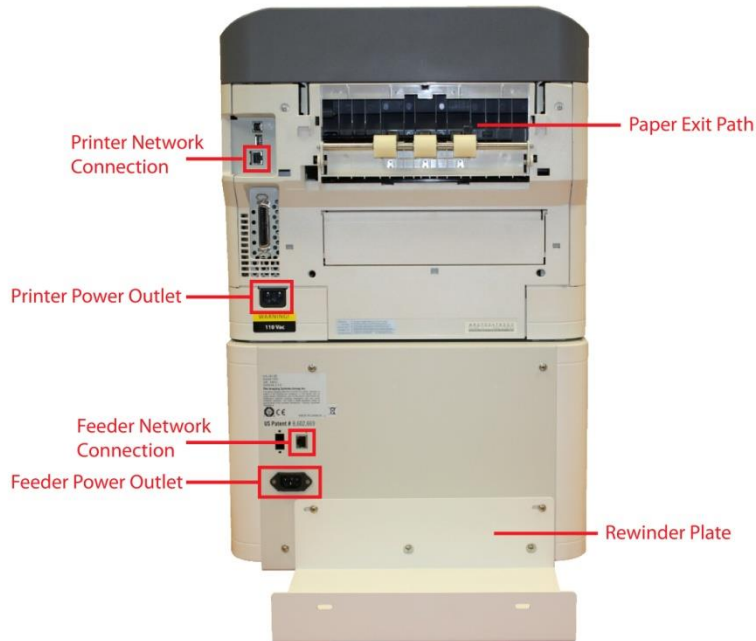

Once the rewriter is installed, you need to connect the network and power cables to the correct outlets. All of the outlets are located on the backside of the iColor 700; connect accordingly.

STEP 11 of 11



Press power button on the side of the printer. Wait for the initialization. You should read **Ready To Print** on the printer panel and **Status: Require Load** on the feeder panel. The rewinder attachment has been successfully installed.

2.2 How To Get Software Installation Files

STEP 1 of 4

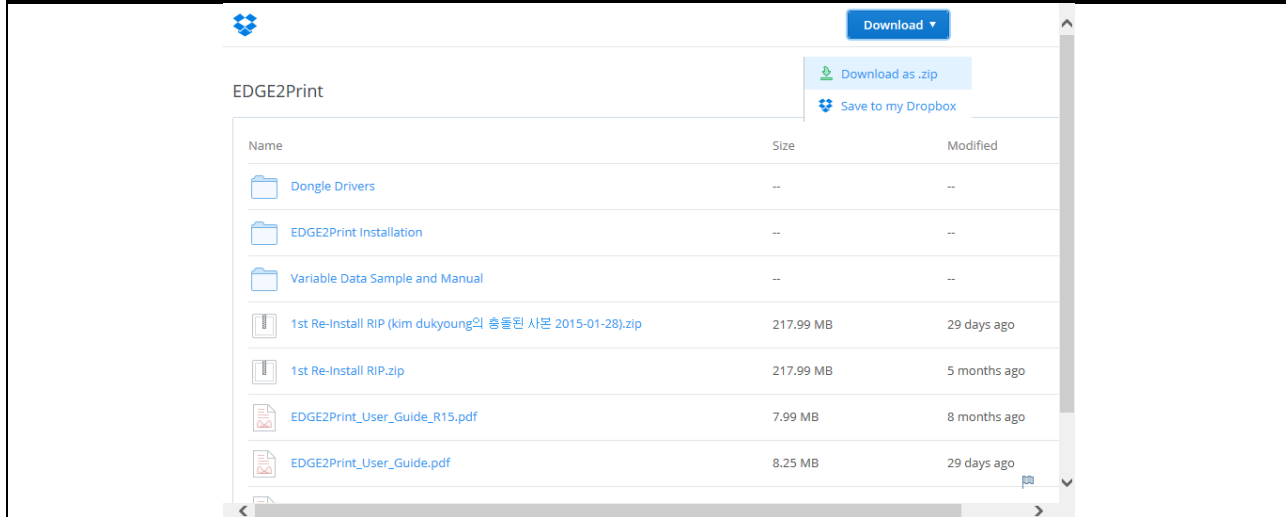

UniNet utilizes Dropbox for sending the software file. Please send UniNet an email for sharing folders. After this email confirmation, UniNet will send a link for the software to your email address. Click the link and you will see the above website. Click **Download** on the top right, and click **Download as .zip**.

STEP 2 of 4

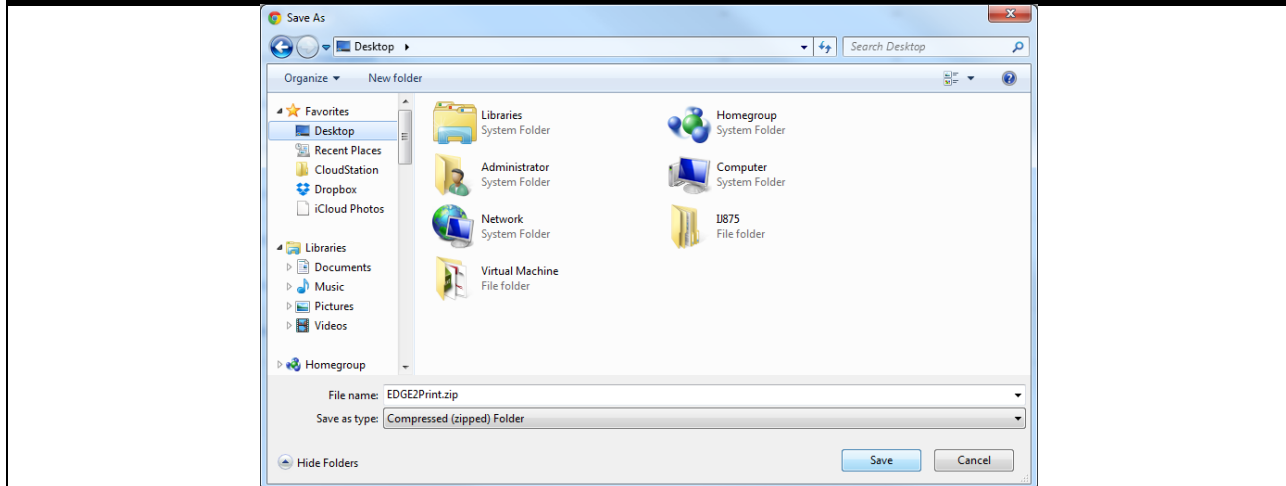

Select a place to save your file. (e.g. on Desktop), Click **Save**.

STEP 3 of 4

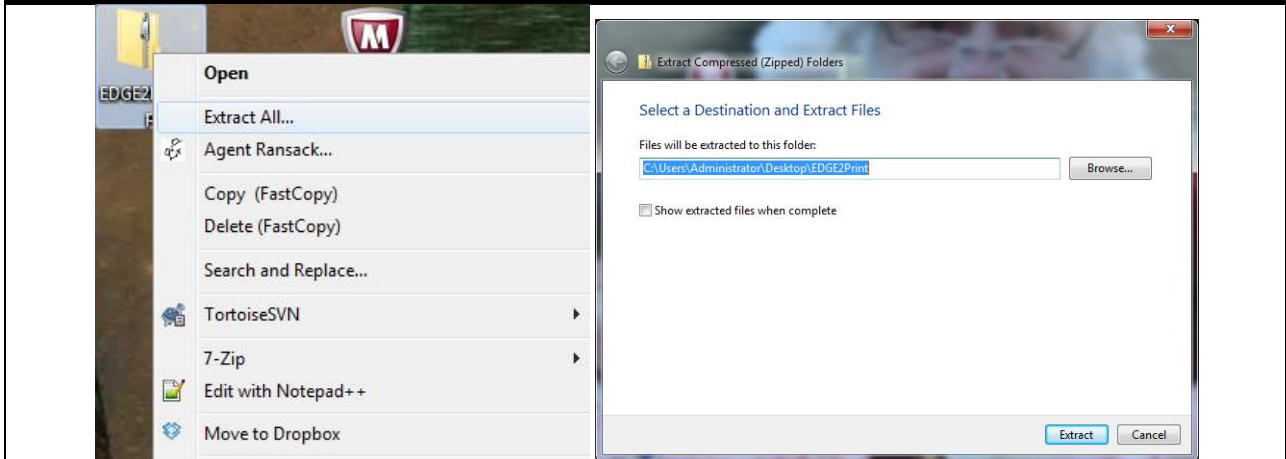

Go to the place to get your .zip file, right click and select **Extract All**. On the pop-up window, select a place to save your folder and click **Extract**.

STEP 4 of 4



Now you have the folder for the software installation.

2.3 Change User Account Control Settings

STEP 1 of 6

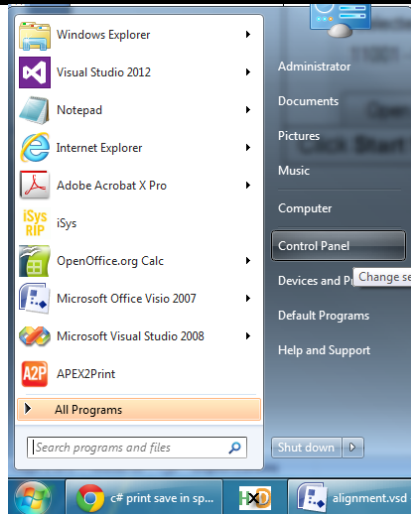

In order to prevent some administration window popping up when you use EDGE2Print, Please change your user account control setting.

Click **Start** from Windows toolbar, and then click **Control Panel**.

STEP 2 of 6

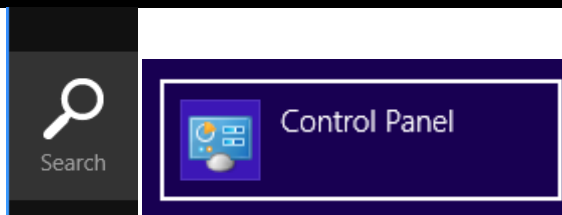

If using Windows 8, point your mouse to the upper-right corner of the screen, move the mouse pointer down, click **Search**, enter **Control Panel** in the search box, and then click **Control Panel**.

STEP 3 of 6



Click **User Account and Family Safety**.

STEP 4 of 6

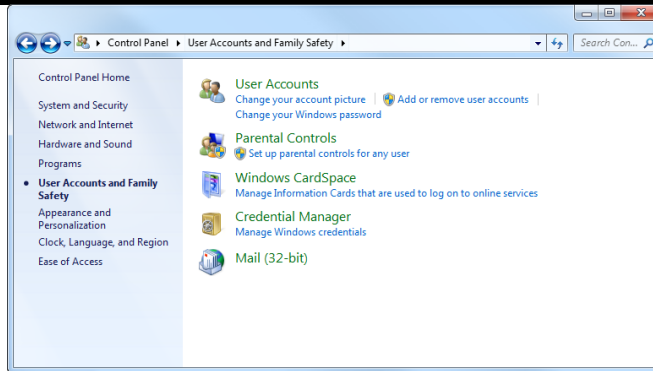

Click **User Accounts**.

STEP 5 of 6

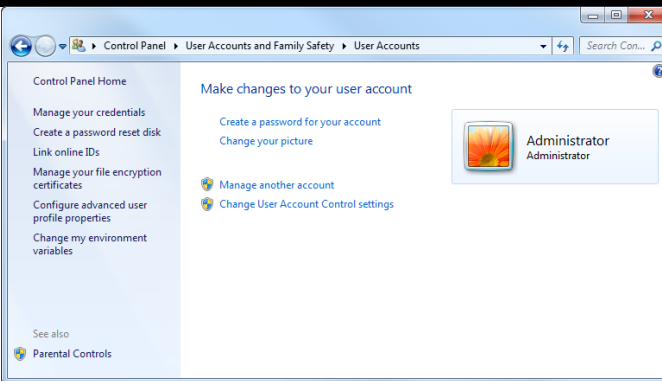

Click **Change User Account Control settings**.

STEP 6 of 6

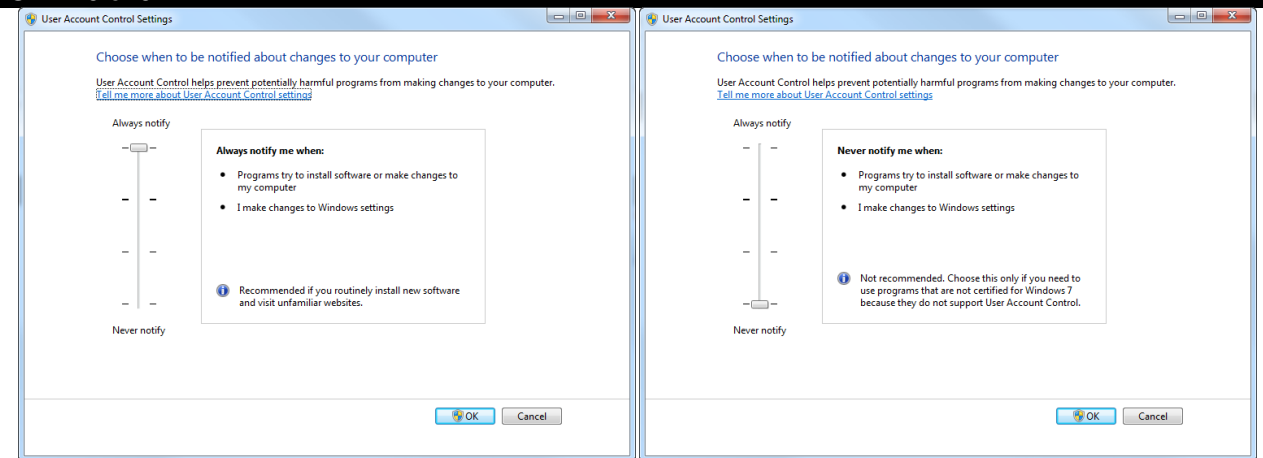

Move the left bar all the way down to the bottom and click **OK**.

2.4 Change Region Format

STEP 1 of 4



To prevent the confusion of measurement units display in EDGE2Print, we recommend to change region format to English (Canada).

Click **Start** from Windows toolbar then click **Control Panel**. (For Windows 8, follow STEP 2 in Section 2.3.)

STEP 2 of 4



Click **Clock, Language, and Region**.

STEP 3 of 4

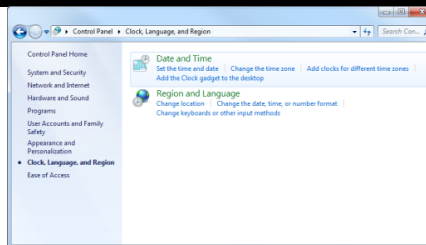

Click **Region and Language**.

STEP 4 of 4

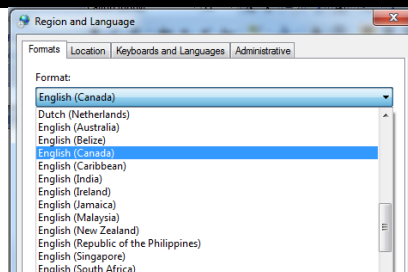

From the **Format** list, select **English (Canada)** and then click **OK**.

2.5 How to Install RIP

STEP 1 of 4

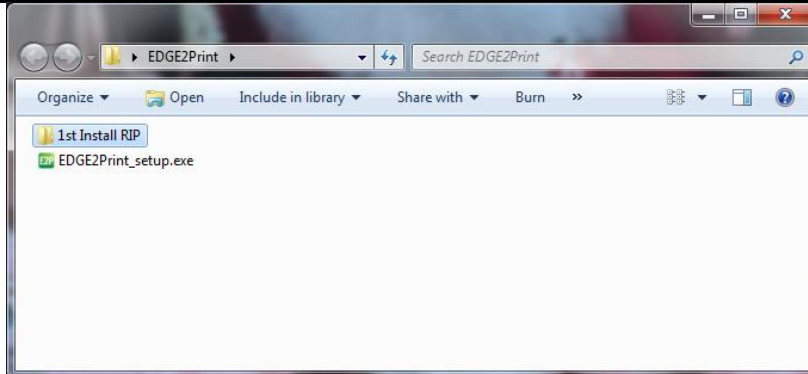

Double click the folder of **1st Re-Install RIP**.

NOTE: RIP must be installed before EDGE2Print.

STEP 2 of 4

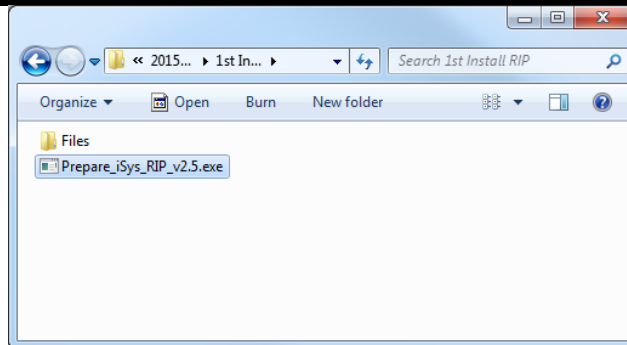

Click **Prepare_UniNet_RIP_v2.5.exe** to install.

STEP 3 of 4

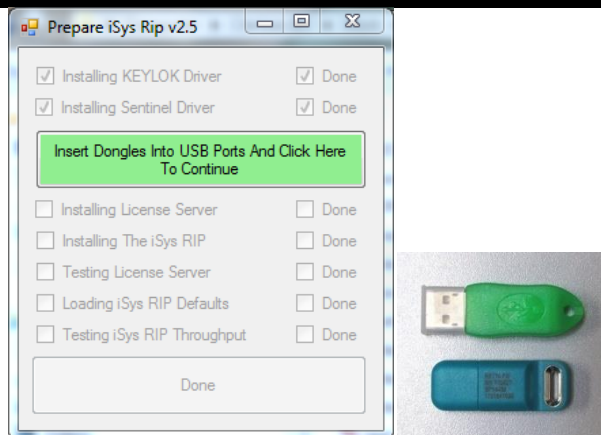

The **KEYLOK Driver** and **Sentinel Driver** will start to install automatically. Wait until the button turns green. Insert your dongles and click the button to continue.

STEP 4 of 4

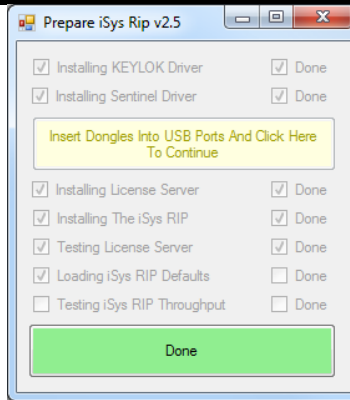

Wait until the **Done** button turns to green. Click it to finish the installation.

2.6 How to Install EDGE2Print

STEP 1 of 4

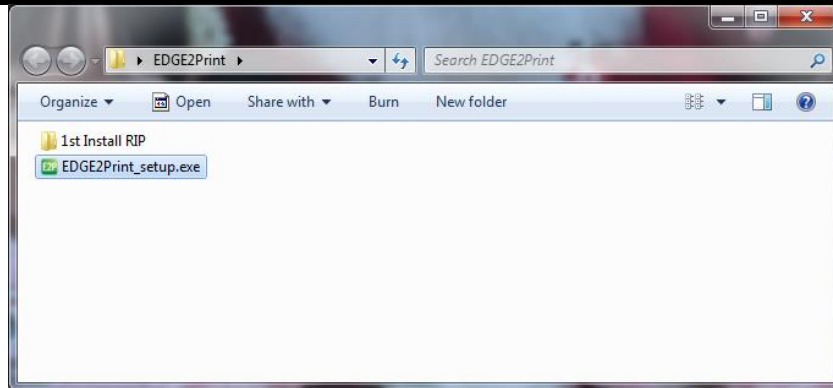

Double click **EDGE2Print_setup.exe**.

STEP 2 of 4

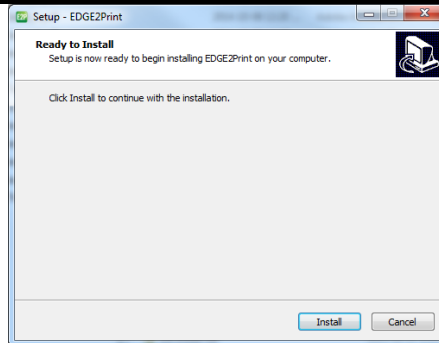

Click **Install** to continue. The window will disappear after the installation is done.

STEP 3 of 4

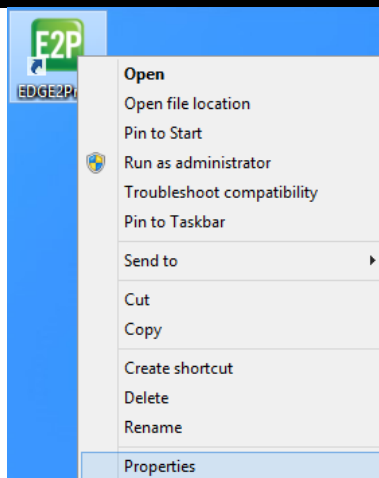

If you're using on Windows 8 and have some administration pop up window when you launch EDGE2Print software, please **right click** the icon, and select **Properties**.

STEP 4 of 4

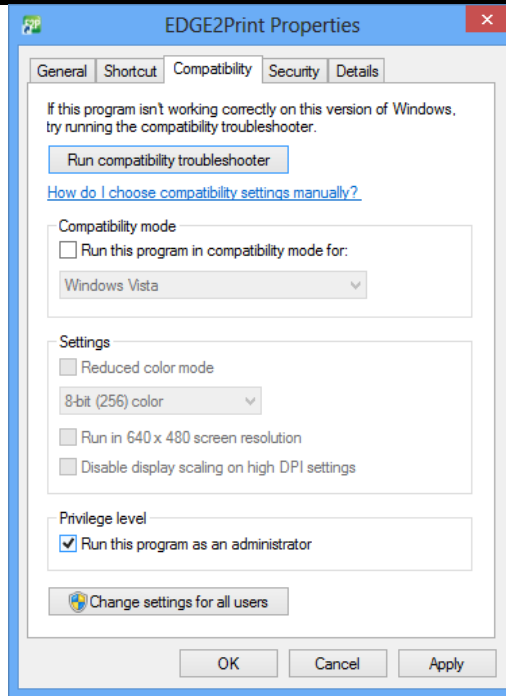

Click **Compatibility** tab, check the box before **Run this program as an administrator**, and click **OK** to apply.

2.7 Setting up the IP Addresses

In order to connect to the iColor 700, you need two predetermined static IP Addresses and two network cables, one for the printer and one for the feeder.

2.7.1 Setting up the IP Address on the Printer

STEP 1 of 10

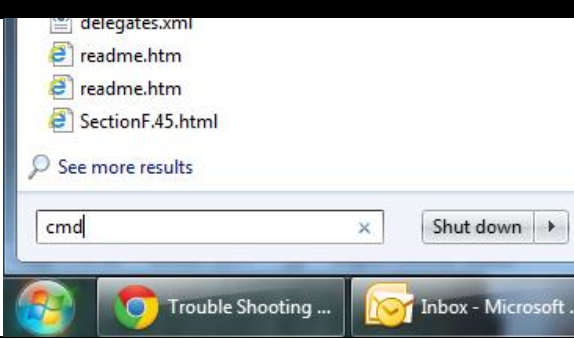

The screenshot shows a Windows search window with the search term 'cmd'. The results list several files: 'delegates.xml', two 'readme.htm' files, and 'SectionF.45.html'. Below the search bar, there are icons for 'Trouble Shooting ...' and 'Inbox - Microsoft ...'. A 'Shut down' button is visible on the right side of the search bar.

Keep the network cable unconnected to the printer. Click **Start** from windows toolbar (For Windows 8, point your mouse to the upper-right corner of the screen, move the mouse pointer down, click **Search**), type **cmd** in the search dialogue and press **Enter**.

NOTE: Before you input the IP in the printer, you must check whether this IP is available to use.

STEP 2 of 10

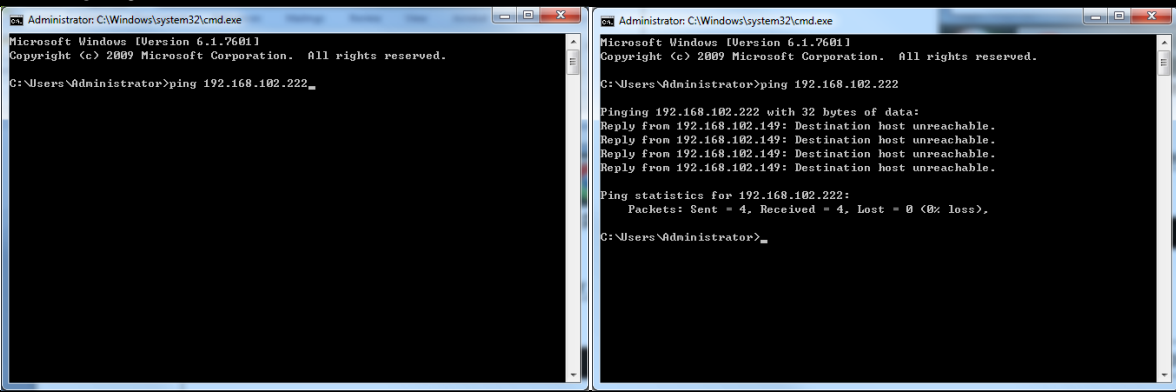

The first screenshot shows a command prompt window with the command 'ping 192.168.102.222' entered. The second screenshot shows the output of the ping command, which indicates that the destination host is unreachable. The output is as follows:

```
Microsoft Windows [Version 6.1.7601]
Copyright (c) 2009 Microsoft Corporation. All rights reserved.

C:\Users\Administrator>ping 192.168.102.222

Microsoft Windows [Version 6.1.7601]
Copyright (c) 2009 Microsoft Corporation. All rights reserved.

C:\Users\Administrator>ping 192.168.102.222

Pinging 192.168.102.222 with 32 bytes of data:
Reply from 192.168.102.149: Destination host unreachable.
Reply from 192.168.102.149: Destination host unreachable.
Reply from 192.168.102.149: Destination host unreachable.
Reply from 192.168.102.149: Destination host unreachable.

Ping statistics for 192.168.102.222:
    Packets: Sent = 4, Received = 4, Lost = 0 (0% loss),
```

Enter "ping <IP address>" (for here is 192.168.102.222) you want to use for the printer, press **Enter**.

If it shows unreachable like the right picture, the IP address is not in use and you can use this IP for your printer.

STEP 3 of 10



Once your IP address is correct, go to your printer panel.
Press **ENTER** to enter the printer menu.
Using **DOWN** arrow to scroll to **Admin Setup**, press **ENTER**.

STEP 4 of 10



At the **Enter Password** prompt, enter the 6-digit Admin password by using the **UP/DOWN** arrow, then **Enter**.
The default password is: *aaaaaa*(6 x a).

STEP 5 of 10



Press **ENTER** to select **Network Setup**.

STEP 6 of 10



Hit the **DOWN** key until you select **IPv4 Address** then **Enter**. Use the **UP/DOWN** arrow keys to set the value you need. Press **Enter** to move across the address. After the value is set, press **Back** to **Network Setup**.

STEP 7 of 10

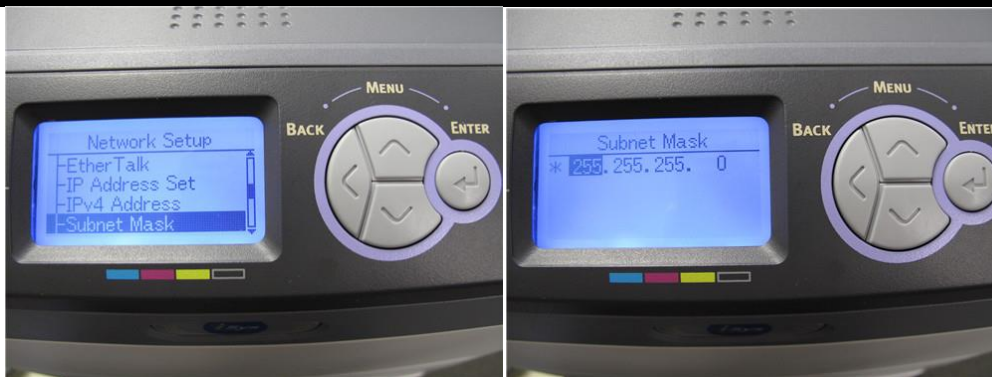

Hit the **DOWN** key to select **Subnet Mask**. Use the **UP/DOWN** arrow keys to set the value you need. Press **Enter** to move across the address. After the value is set, press **Back** to **Network Setup**. (The default subnet mask is 255.255.255.0).

STEP 8 of 10

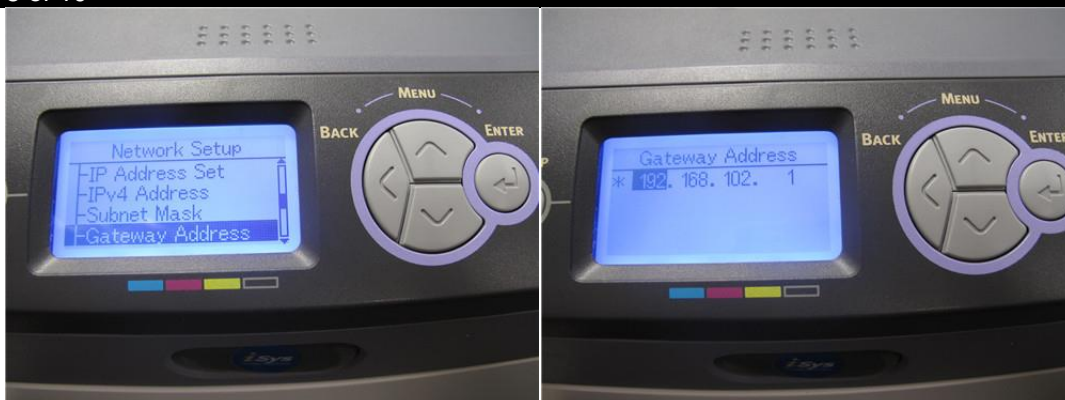

Hit the **DOWN** key to select **Gateway Address**. Use the **UP/DOWN** arrow keys to set the value you need. Press **Enter** to move across the address. After the value is set, press **Back** to **Network Setup**.

STEP 9 of 10



Press **ON LINE** to exit the menu. **NOTE:** Write down this IP address as you will need for the software.

STEP 10 of 10

```
Administrator: C:\Windows\system32\cmd.exe
C:\Users\Administrator>ping 192.168.102.222

Pinging 192.168.102.222 with 32 bytes of data:
Reply from 192.168.102.149: Destination host unreachable.
Reply from 192.168.102.149: Destination host unreachable.
Reply from 192.168.102.149: Destination host unreachable.
Reply from 192.168.102.149: Destination host unreachable.

Ping statistics for 192.168.102.222:
    Packets: Sent = 4, Received = 4, Lost = 0 (0% loss),

C:\Users\Administrator>ping 192.168.102.222

Pinging 192.168.102.222 with 32 bytes of data:
Reply from 192.168.102.222: bytes=32 time<1ms TTL=64
Reply from 192.168.102.222: bytes=32 time<1ms TTL=64
Reply from 192.168.102.222: bytes=32 time<1ms TTL=64
Reply from 192.168.102.222: bytes=32 time<1ms TTL=64

Ping statistics for 192.168.102.222:
    Packets: Sent = 4, Received = 4, Lost = 0 (0% loss),
    Approximate round trip times in milli-seconds:
        Minimum = 0ms, Maximum = 0ms, Average = 0ms

C:\Users\Administrator>
```

Connect the cable to the printer and now go back to your computer cmd interface, enter "ping <IP address>" (for here is 192.168.102.222), press **Enter** again. You should get response this time. If you're not getting reply as in the picture, please contact your IT support team.

2.7.2 Setting up the IP Address on the Feeder

STEP 1 of 10

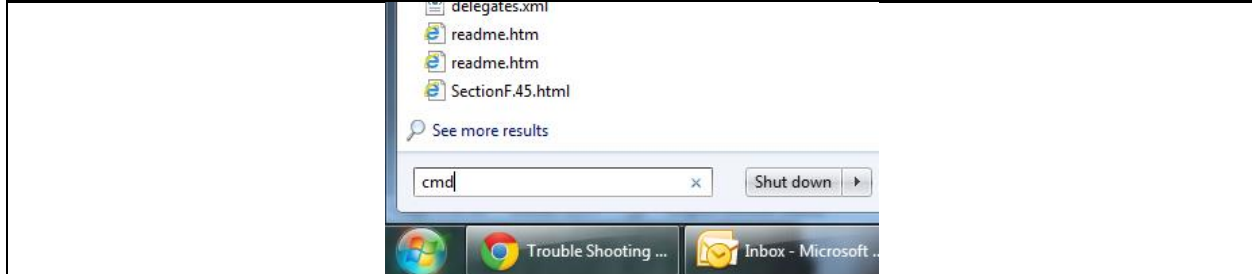

Keep the network cable unconnected to the printer. Click **Start** from windows toolbar (If using Windows 8, point your mouse to the upper-right corner of the screen, move the mouse pointer down, click **Search**), type **cmd** in the search dialogue and press **Enter**.

NOTE: Before you input the IP in the feeder, you must check whether this IP is available to use.

STEP 2 of 10

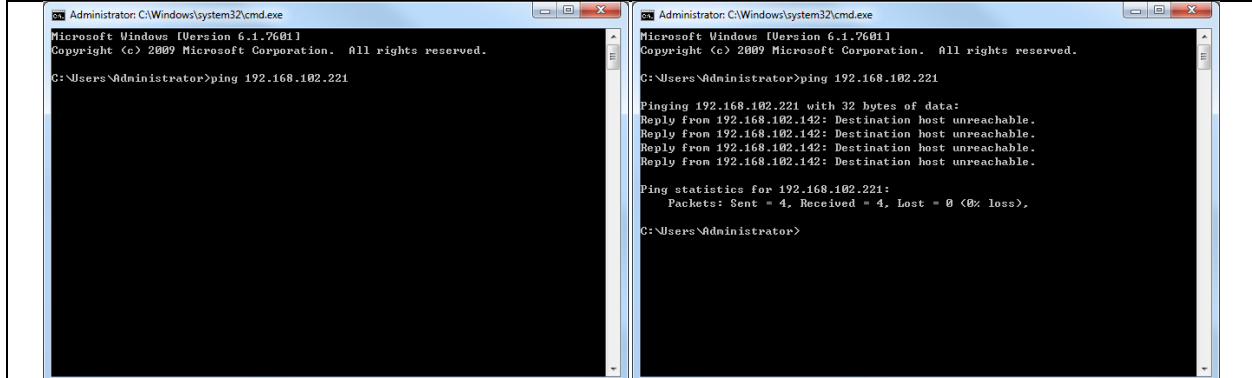

Enter "ping <IP address>" (for here is 192.168.102.221) you want to use for the printer, press **Enter**. If it shows unreachable like the right picture, the IP address is not in use and you can use this IP for your feeder.

STEP 3 of 10



Once your IP address is correct, go to your feeder panel. Press **On Line** to turn the feeder Offline.

STEP 4 of 10



Press **Menu** button three times until **M3: Network Settings** is shown.

STEP 5 of 10

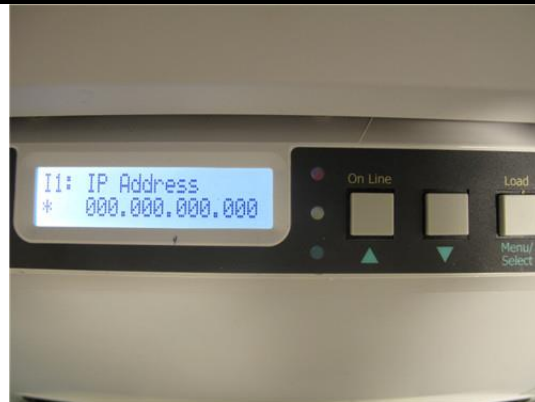

Press the **UP** arrow key to get **I1: IP Address**.

STEP 6 of 10

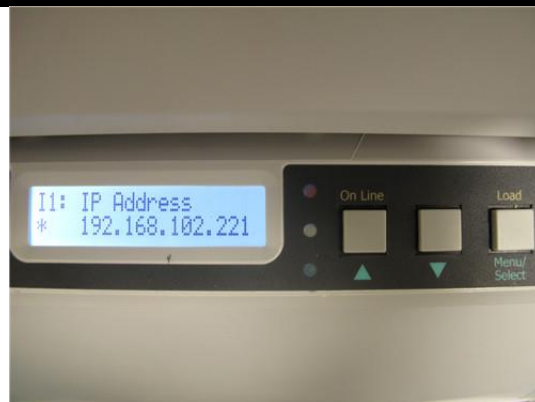

Hold the **Menu** button until the * starts to flash. Use the **UP** and **DOWN** arrow keys to set the values. Press **Menu** button to move across the IP address. When the address is set, hold the **Menu** button until the * stops to flash. The IP address is now set.

STEP 7 of 10

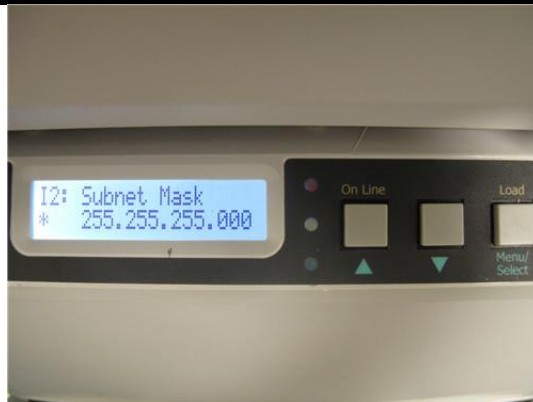

Press the **UP** arrow key to set the **Subnet Mask**. The default subnet mask is 255.255.255.0. If that needs to be changed, follow the same procedure as for the IP Address in STEP 6.

STEP 8 of 10

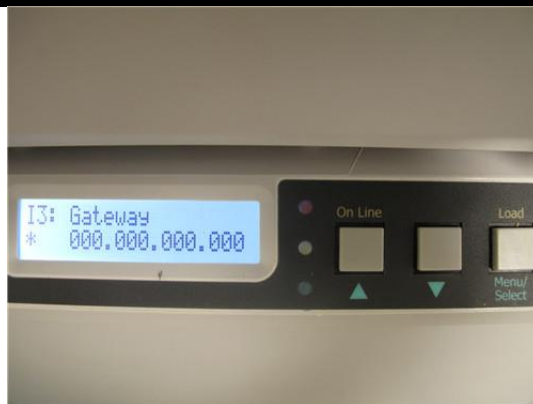

Press the **UP** arrow key to get to **I3: Gateway**. Use the same procedure to set the Gateway as used to set the IP Address in STEP 6 if necessary.

STEP 9 of 10



Press **Menu** button to return to **Offline**. Press **On Line** to apply the network setting. It will show **Msg: Setting Network**. After the setting is done, the feeder panel should read **Status: Require Load**.

NOTE: Write down this IP address as you will need for the software.

STEP 10 of 10

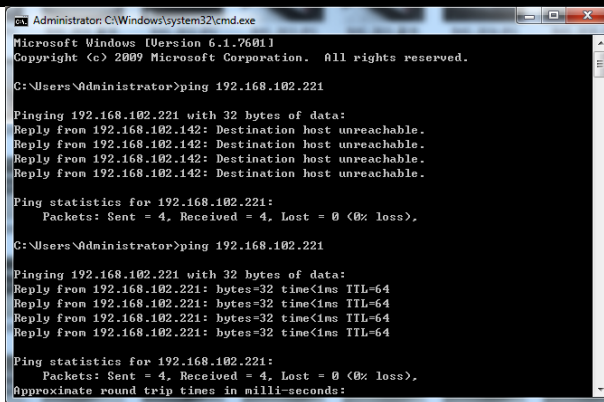

```
Administrator C:\Windows\system32\cmd.exe
Microsoft Windows [Version 6.1.7601]
Copyright (c) 2009 Microsoft Corporation. All rights reserved.

C:\Users\Administrator>ping 192.168.102.221

Pinging 192.168.102.221 with 32 bytes of data:
Reply from 192.168.102.142: Destination host unreachable.
Reply from 192.168.102.142: Destination host unreachable.
Reply from 192.168.102.142: Destination host unreachable.
Reply from 192.168.102.142: Destination host unreachable.

Ping statistics for 192.168.102.221:
    Packets: Sent = 4, Received = 4, Lost = 0 (0% loss),

C:\Users\Administrator>ping 192.168.102.221

Pinging 192.168.102.221 with 32 bytes of data:
Reply from 192.168.102.221: bytes=32 time<1ms TTL=64
Reply from 192.168.102.221: bytes=32 time<1ms TTL=64
Reply from 192.168.102.221: bytes=32 time<1ms TTL=64
Reply from 192.168.102.221: bytes=32 time<1ms TTL=64

Ping statistics for 192.168.102.221:
    Packets: Sent = 4, Received = 4, Lost = 0 (0% loss),
    Approximate round trip times in milli-seconds:
```

Connect the cable to the feeder and now go back to your computer cmd interface, enter "ping <IP address>" (for here is 192.168.102.221), press **Enter** again. You should get response this time. If you're not getting reply as in the picture, please contact your IT support team.

3 Before Printing

3.1 EDGE2Print User Interface

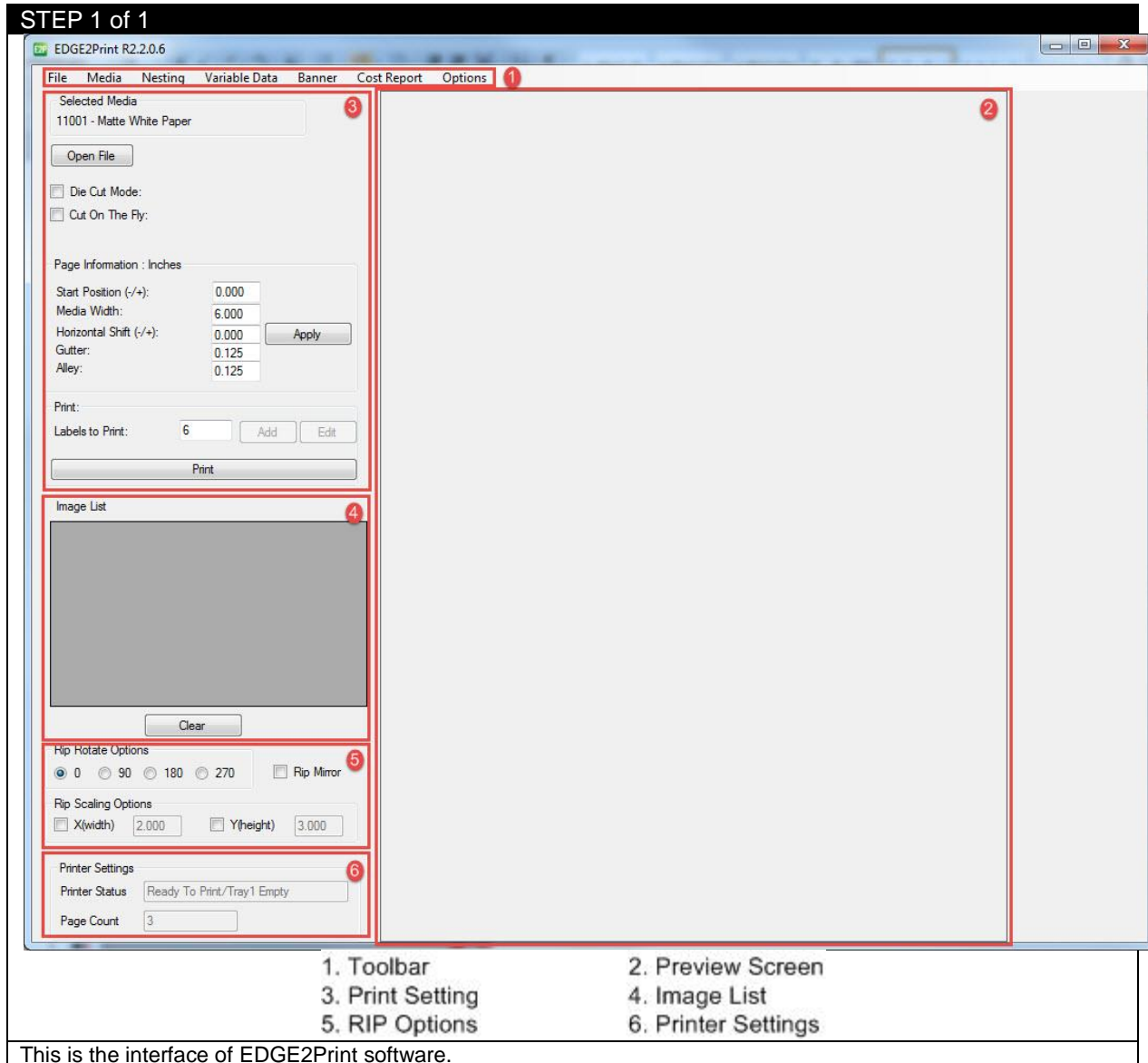

3.2 Input IP Addresses into EDGE2Print

STEP 1 of 2

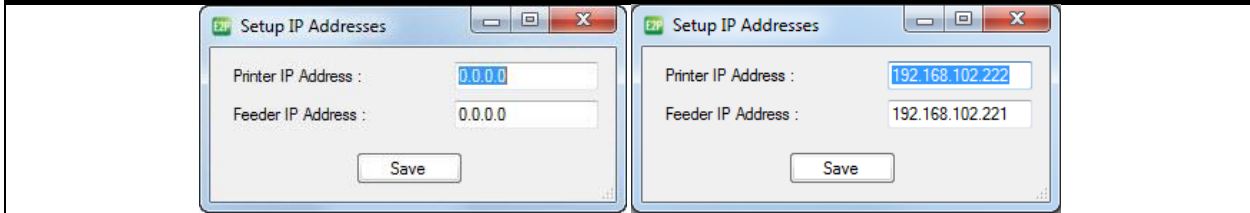

Launch the software. This window will pop up automatically if it is the first time. Input the IP addresses for the printer and feeder, then click **Save**.

STEP 2 of 2

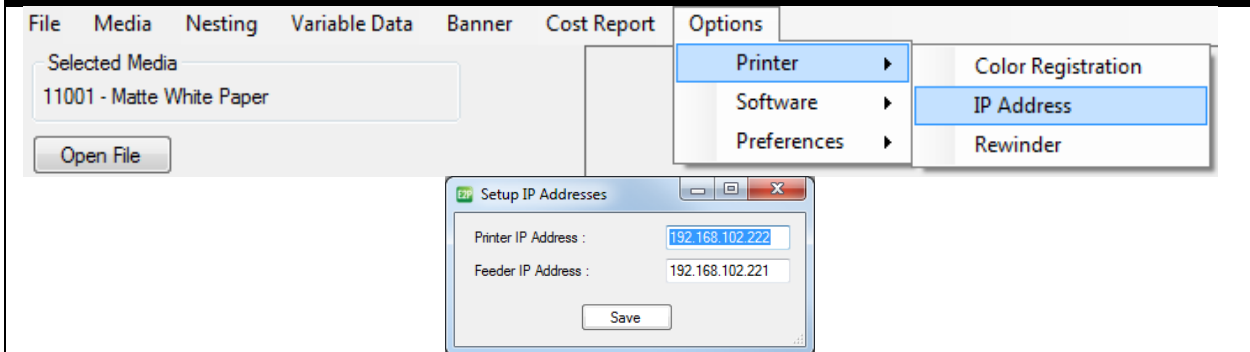

If you need to change the IP address, click **Options→Printer→IP Address** from the toolbar, you will get the same window as in STEP 1.

3.3 Changing the Color Registration

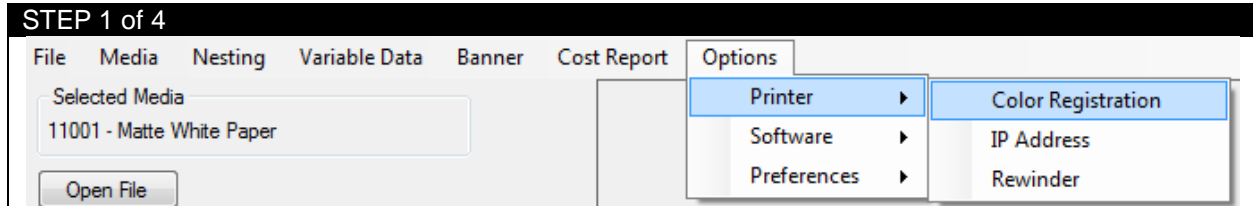

Select **Options**→**Printer**→**Color Registration** from the toolbar.

Go to the front panel of the printer and select the **Media Type** and **Media Weight**, based on the media settings you selected in the software library. You will want to ensure that your front panel settings and software settings are the same so you receive the exact results that are to be expected. If you do not have an exact match with the front panel and media library settings, there is potential for an error on the front panel.

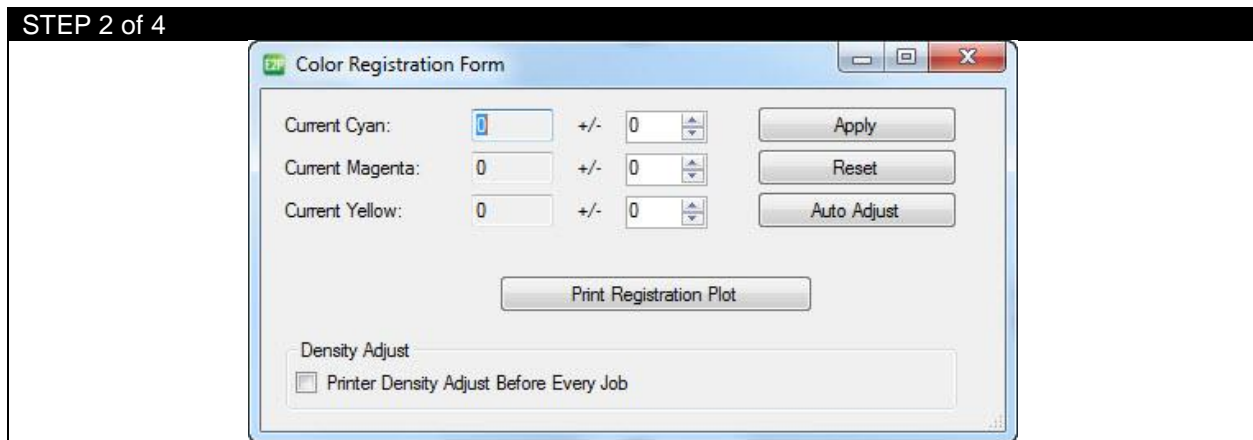

Click **Print Registration Plot**.

STEP 3 of 4



The printer will print a similar page that will aid in determining the proper registration values across CMY.

IMPORTANT: Use the third page printed to determine the values.

Using a printer's loupe or best judgment, determine the best values. In this case, the correct values are as follows: C:6 M:4 Y:0; this is because the pixels are perfectly filled within the boxes.

STEP 4 of 4

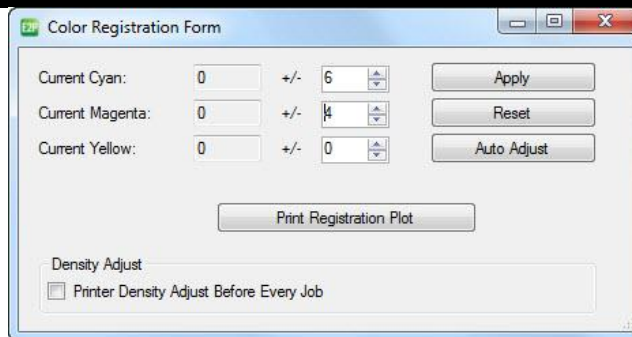

Input the values determined in the previous step and click **Apply** to set. **NOTE:** If there are troubles with the color density, check **Printer Density Adjust Before Every Job**.

3.4 Setting up the Cost Estimator

STEP 1 of 2

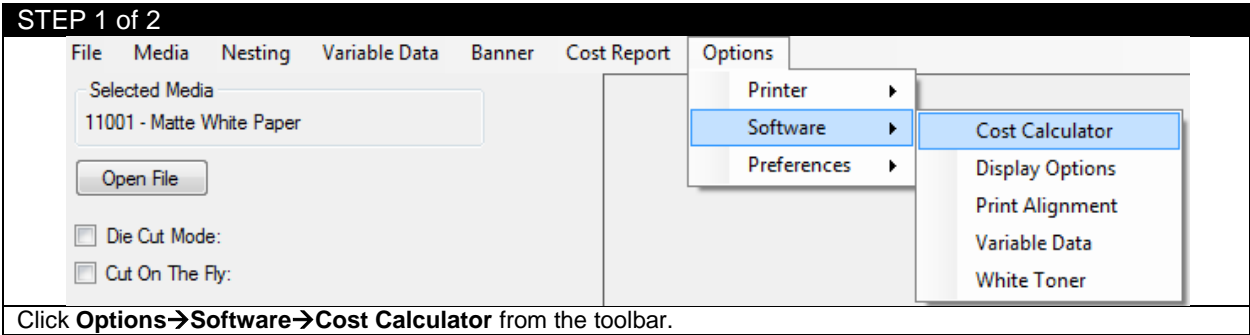

The screenshot shows a software window with a menu bar containing 'File', 'Media', 'Nesting', 'Variable Data', 'Banner', 'Cost Report', and 'Options'. The 'Options' menu is open, showing sub-menus for 'Printer', 'Software', and 'Preferences'. The 'Software' sub-menu is selected, and the 'Cost Calculator' option is highlighted. In the background, the 'Media' menu is open, showing 'Selected Media' as '11001 - Matte White Paper' and an 'Open File' button. There are also checkboxes for 'Die Cut Mode' and 'Cut On The Fly'.

Click **Options**→**Software**→**Cost Calculator** from the toolbar.

STEP 2 of 2

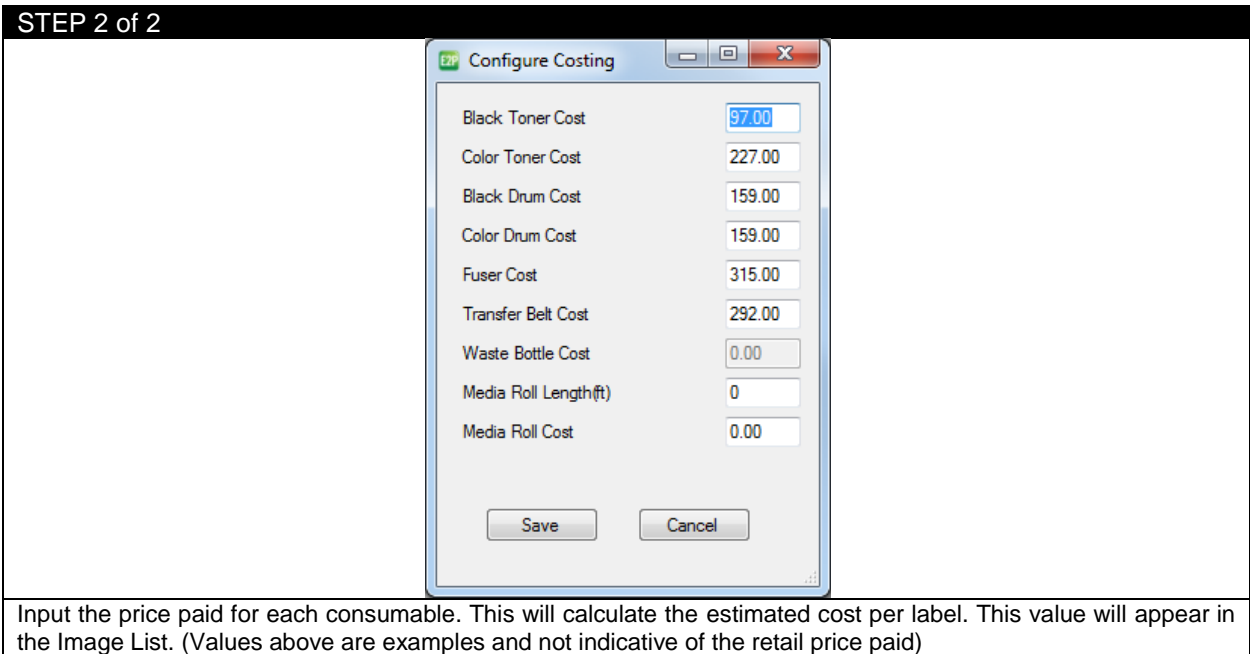

The screenshot shows a 'Configure Costing' dialog box with the following fields and values:

Consumable	Cost
Black Toner Cost	97.00
Color Toner Cost	227.00
Black Drum Cost	159.00
Color Drum Cost	159.00
Fuser Cost	315.00
Transfer Belt Cost	292.00
Waste Bottle Cost	0.00
Media Roll Length(ft)	0
Media Roll Cost	0.00

Buttons: Save, Cancel

Input the price paid for each consumable. This will calculate the estimated cost per label. This value will appear in the Image List. (Values above are examples and not indicative of the retail price paid)

3.5 Changing Units of Measurement

STEP 1 of 2

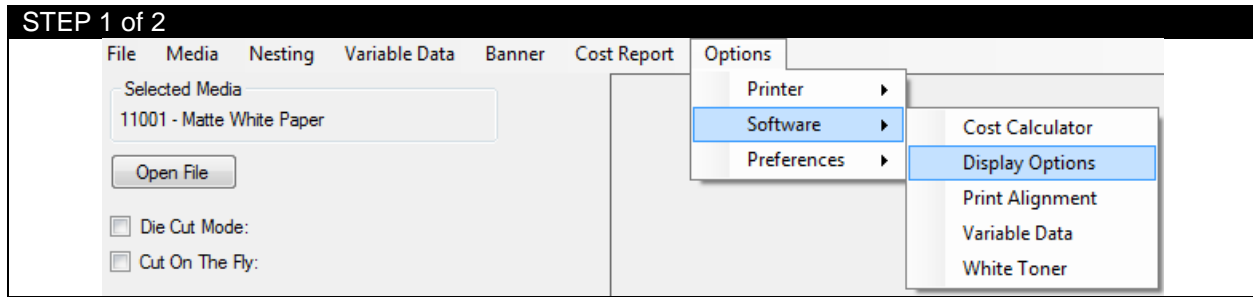

The screenshot shows the software's main menu bar with 'Options' selected. A dropdown menu is open, showing 'Printer', 'Software', and 'Preferences'. The 'Software' submenu is also open, showing 'Cost Calculator', 'Display Options', 'Print Alignment', 'Variable Data', and 'White Toner'. The 'Display Options' item is highlighted in blue.

Select **Options**→**Software**→**Display Options** from the toolbar.

STEP 2 of 2

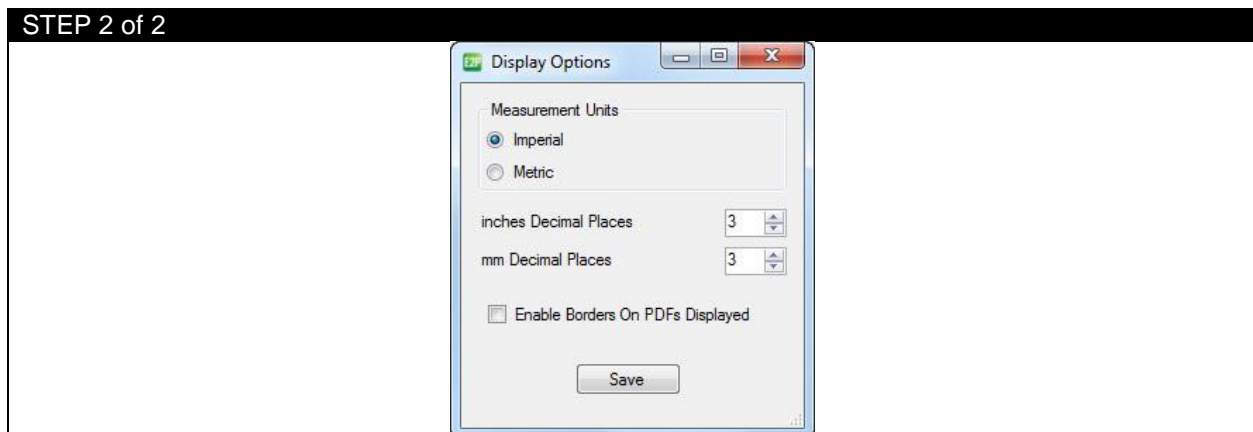

The screenshot shows the 'Display Options' dialog box. Under 'Measurement Units', 'Imperial' is selected with a radio button. Below, 'inches Decimal Places' and 'mm Decimal Places' are both set to 3. There is an unchecked checkbox for 'Enable Borders On PDFs Displayed' and a 'Save' button at the bottom.

Select your preferred measurement units to display and click **Save**.

3.6 Changing Borders on PDF Preview

STEP 1 of 3

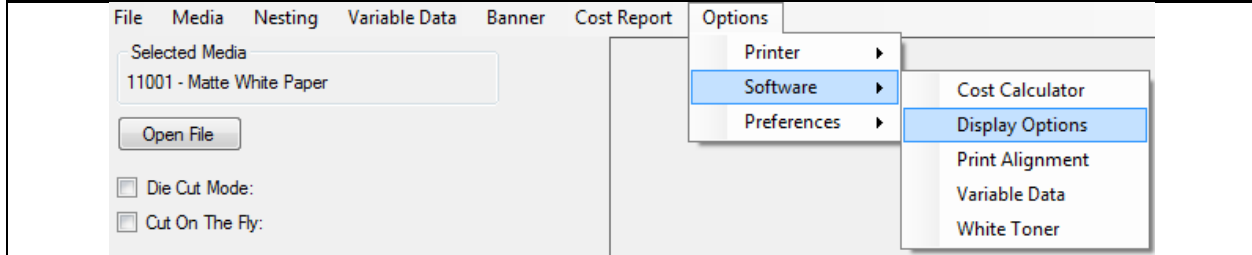

Select **Options**→**Software**→**Display Options** from the toolbar.

STEP 2 of 3

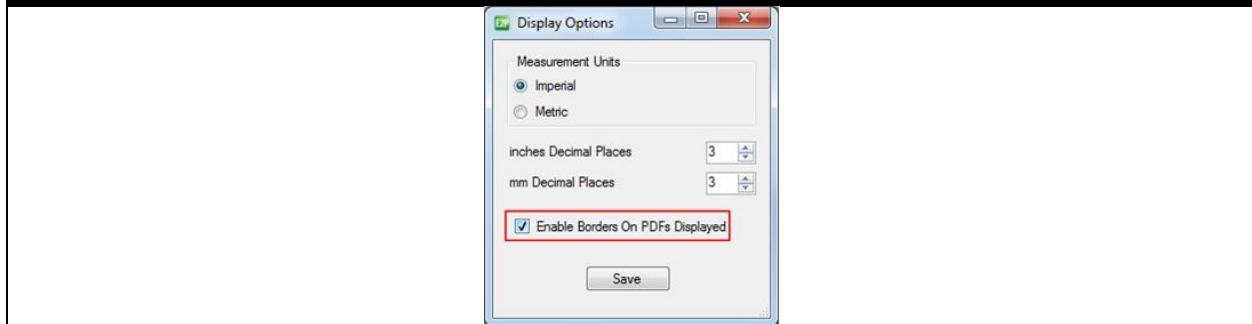

Check the box to enable borders on PDFs display or uncheck the box to disable.

STEP 3 of 3

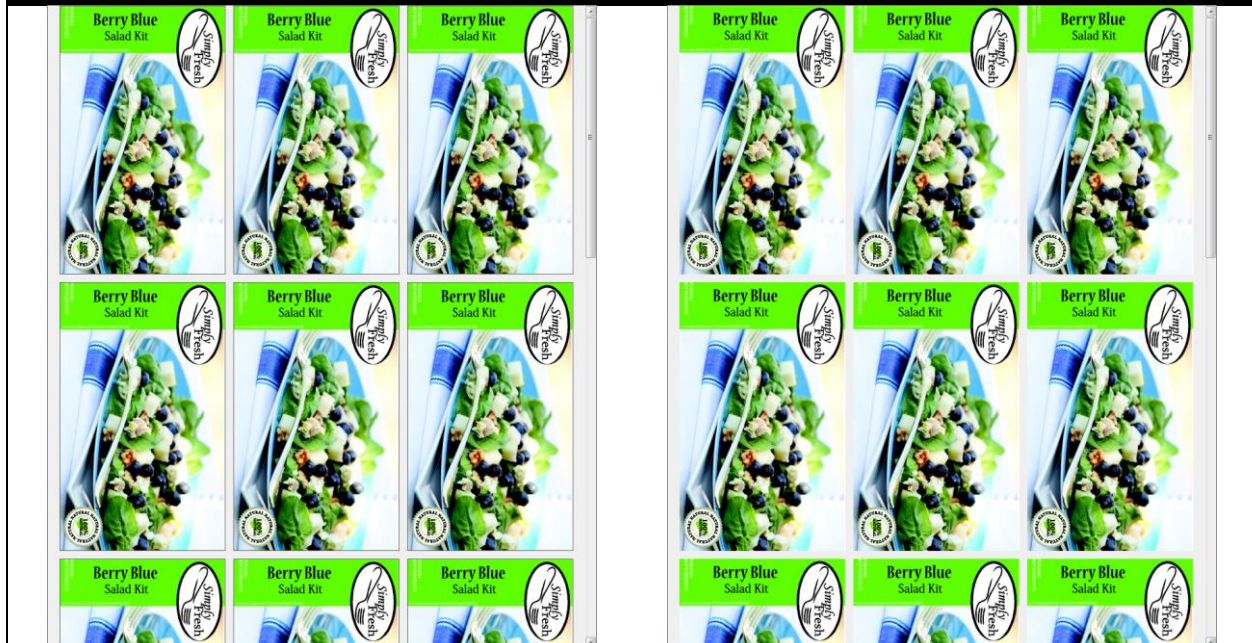

Left one has the border enabled and right one has the border disabled.

3.7 Measuring Your Media

STEP 1 of 6

Page Information : Inches	
Start Position (-/+):	<input type="text" value="0.000"/>
Media Width:	<input type="text" value="8.250"/>
Horizontal Shift (-/+):	<input type="text" value="0.000"/>
Gutter:	<input type="text" value="0.125"/>
Alley:	<input type="text" value="0.125"/>
<input type="button" value="Apply"/>	

This is the interface of media page information in EDGE2Print software.

NOTE:

Gutter is the distance of the horizontal gap between labels.

Alley is the distance of the vertical gap between labels.

STEP 2 of 6

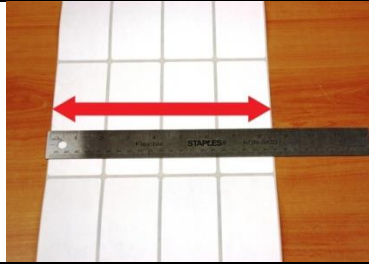

Measure the total width of paper. Input the value into **Media Width**.

STEP 3 of 6



Measure the distance of horizontal gap. Input the value into **Gutter**.

STEP 4 of 6

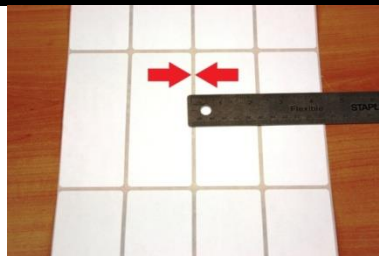

Measure the distance of vertical gap. Put the value into **Alley**.

STEP 5 of 6

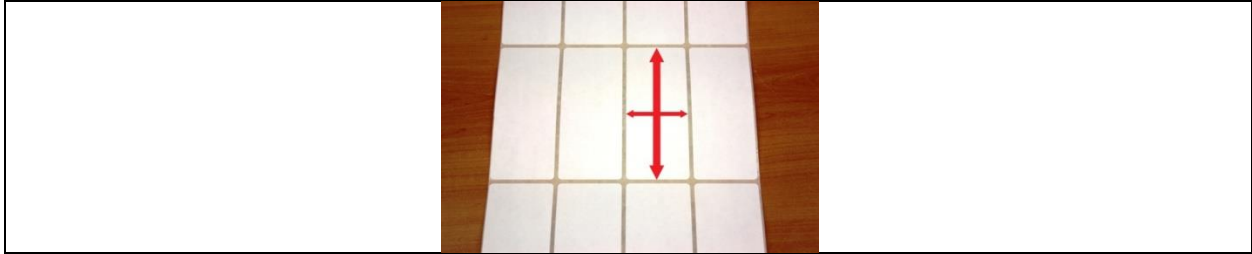

You also should measure the **width** and **height** of the label. Save the values for later.

STEP 6 of 6



Measure the right border of the label. The distance from the edge of the facestock to the edge of the should be less than 2mm because of the sensor location on the guide.

Measuring Tip

In order to get more precise value of gutter, there is a better way! Measure as least one meter of the media, and measure the height of one label. Then calculate the distance of the gap. The longer you measure the media, the more precise value you will get.

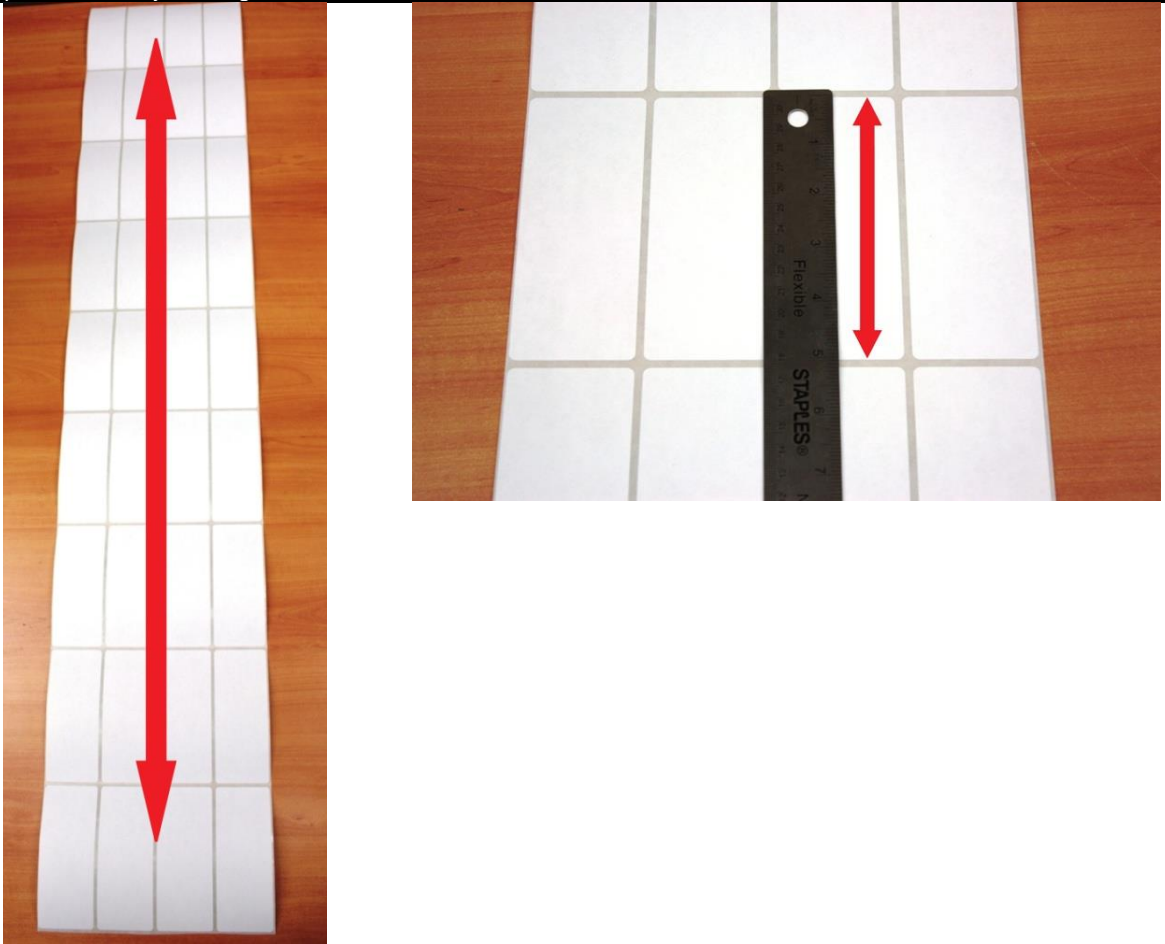

Ex. For the left picture, we measure **9 label lengths** plus **9 gutter lengths**; the total length is **1171.58 mm** (46.125 inches).

Then measure one label length, which is **127mm** (5 inches).

Therefore, the gutter value is **$(1171.58/9)-127= 3.177$ mm**

3.8 Loading Media for Continuous Printing

IMPORTANT: Only use with media width ranging from 6" to 8.5" wide. If use with media width less than 6", please use a narrow fuser.

NOTE: Maximum Printable Width is 8.25".

STEP 1 of 13



Note secure paper roll packaging and end pieces



Unpack the media, make sure the sides of the roll are straight and flush with the core.

STEP 2 of 13

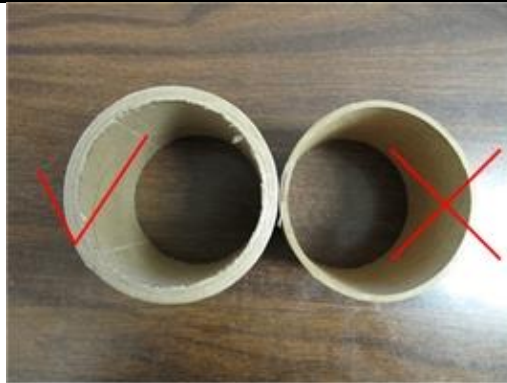

Make sure the core is thicker than 4mm. If not, when the roll is running to end, it will go out of the extension arm.

STEP 3 of 13

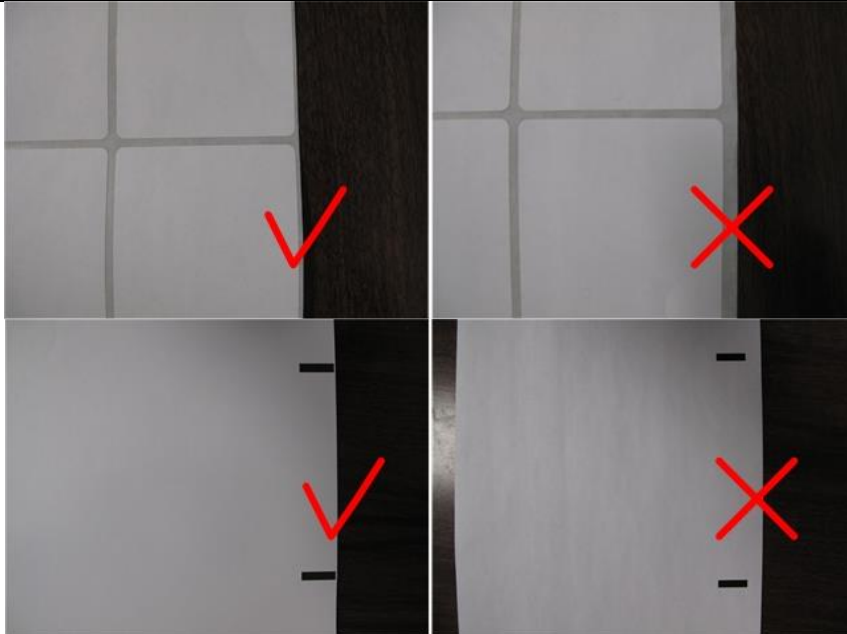

If you're using a die cut media, make sure the margin is less than 2mm. If you're using a back/top mark media, make sure the black mark offset from edge is less than 1mm. If the margin is too large, the sensor can't read the gap/mark.

STEP 4 of 13



Open the feeder tray by pushing the black tray latches inward and pulling the tray outwards.

STEP 5 of 13

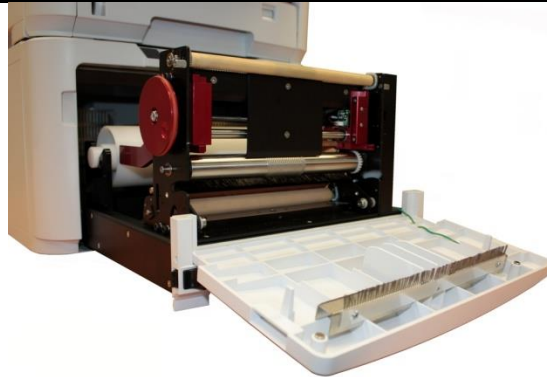

Pull out the feeder tray and open the front cover.

STEP 6 of 13

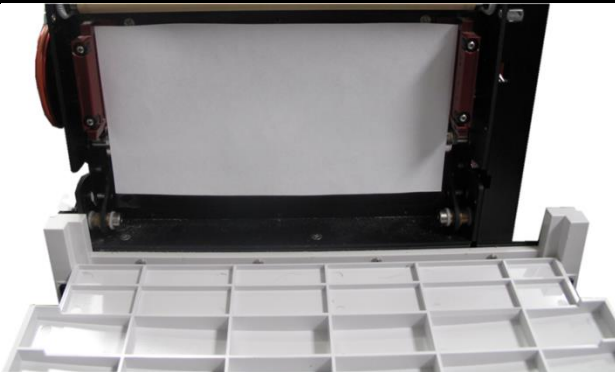

Cut a small piece of the media to adjust the width of the guides.

Open the left and right media guides and place the paper between the guides. Use the width adjustment wheel to adjust the width, making sure there is no space on both sides and the paper can pass through with no tension.

STEP 7 of 13



Remove the plastic spindle and insert it into the core of the media roll, ensuring that you keep the edges of the roll completely flush with the core.

Place the roll in the feeder between the extension arms, with the leading edge of the material at the bottom of the tray. Adjust the width of the extension arms to fit the paper roll's width, if necessary.

STEP 8 of 13

View #1

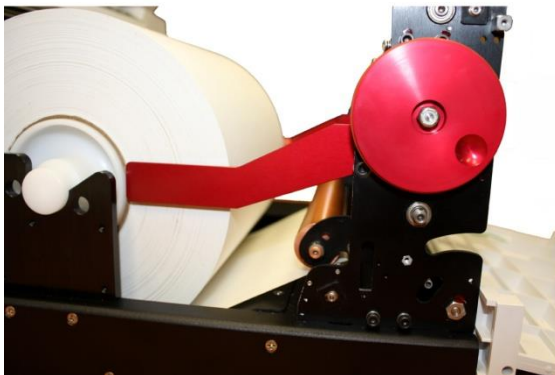

View #2

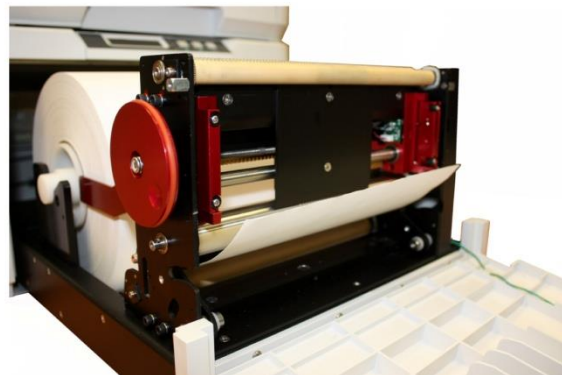

Feed the media through, ensuring it is between the tension and pinch rollers.

STEP 9 of 13

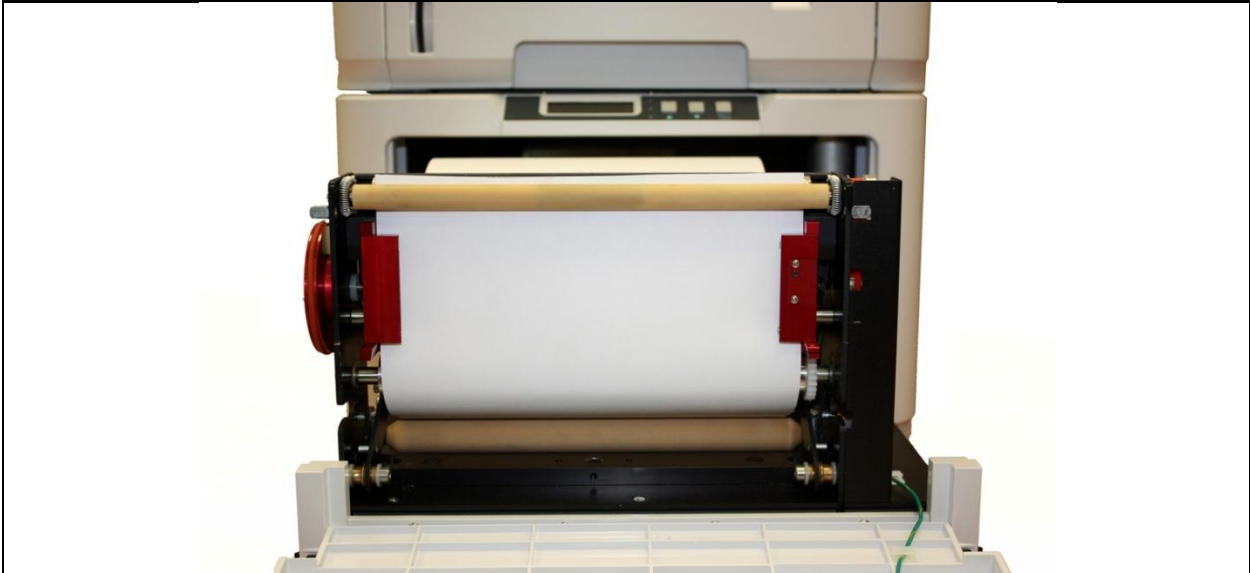

With the media flush against the back plate in the feeder, ensure that there is no extra space on each side of the media and the left/right media guides.

Feed the media underneath the drive roller and ensure that the paper is at the same level as the top of the rollers. Back wind the roll if necessary.

Close the red left/right media guides. Ensure that the media is not buckling or too snug against the guides before proceeding to the next step.

STEP 10 of 13



Close the front cover and push the tray in.

STEP 11 of 13



Power on the printer. When the feeder displays "**Status: Require Load**," press the **Load** button on the feeder. The media will be fed upwards and cut the substrate, leaving a clean leading edge for printing.

STEP 12 of 13



After the feeder cuts the paper, remove the Cut on the Fly module and scrap material. Put the Cut on the Fly Module back in position.

STEP 13 of 13



Now the feeder should read **Status: Idle**.

3.9 Sensor Calibration for Die-cut Label Printing

STEP 1 of 6

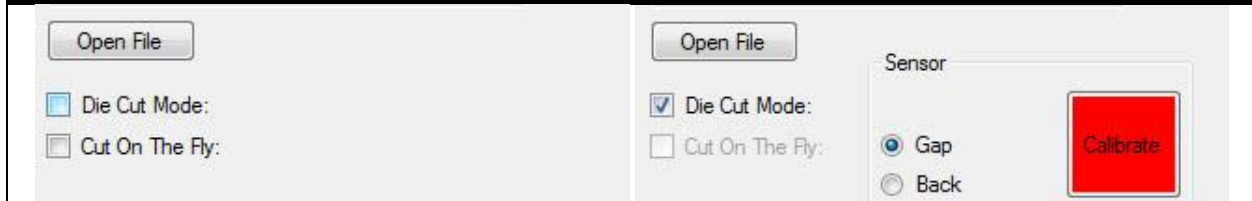

If your media is die cut, select **Die Cut Mode**. Then select the **Sensor Type**. (We will use the **Gap Sensor** as the example in the following instructions.)

NOTE: If the **Calibrate** button is red, it means the sensor needs calibration before printing.

STEP 2 of 6

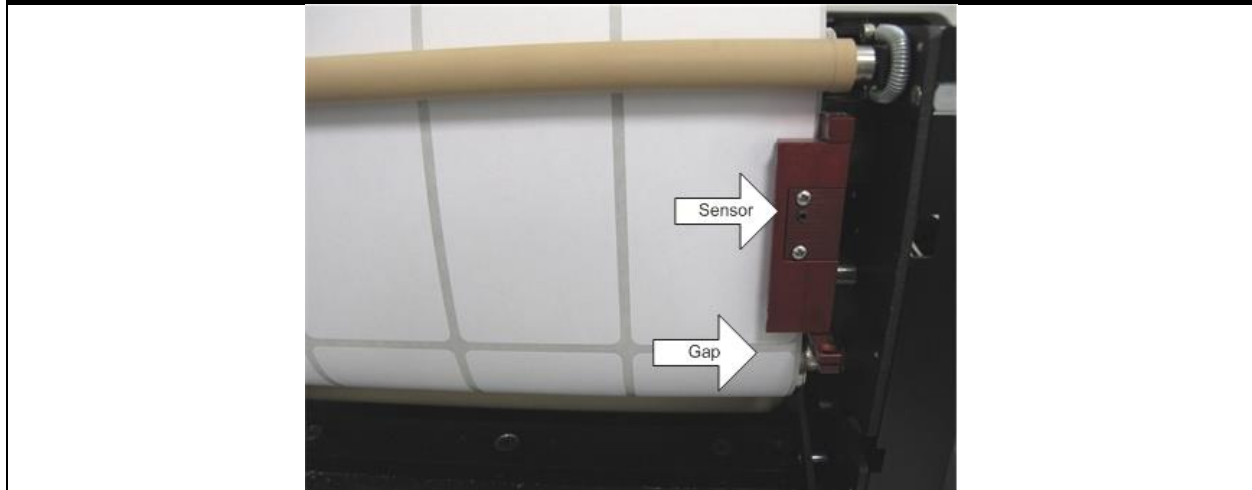

Refer to STEP 1-8 of “Loading Media for Continuous Printing” for how to load the roll of media. After the die cut roll is loaded into the tray, line up the gap of the labels about one inch below the sensor.

Close the left/right media guides. Backwind the roll to ensure there is no tension when the sensor is calibrating. If the roll is fully wound and has tension on it, it will skew the calibration. Close the front cover and push the tray in.

STEP 3 of 6

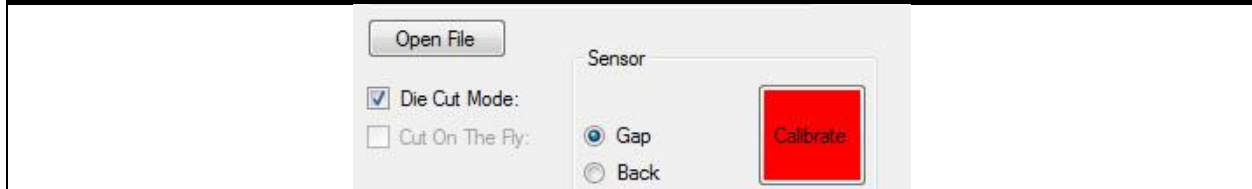

After the media is properly loaded, click **Calibrate** in the software.

STEP 4 of 6

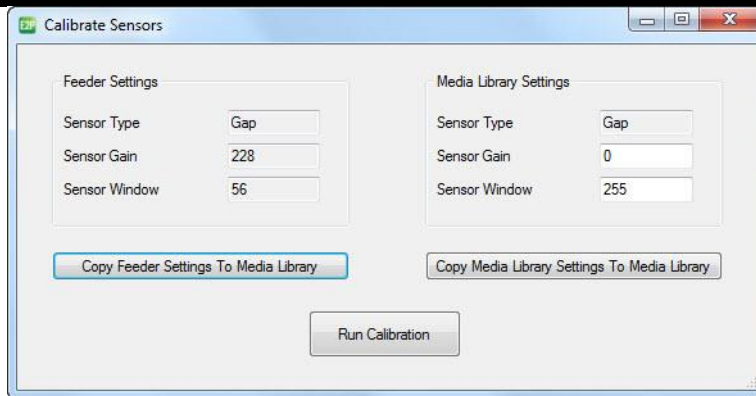

Click **Run Calibration**. The printer will run the paper to the nearest gap mark.

NOTE: You can use previously stored values in the feeder from the last use by clicking **Copy Feeder Settings To Media Library**. You can also manually input the values for Sensor Gain and Sensor Window under the Media Library Settings, and then click **Copy Media Library Settings To Media Library** to update the values in the feeder.

STEP 5 of 6

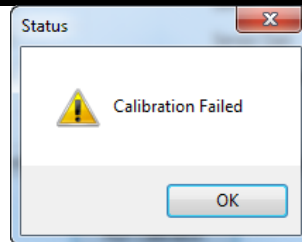

If the calibration did not work, an error screen will pop up.

Adjust the roll again and make sure the gap of the label is about one inch below the sensor then perform another calibration.

STEP 6 of 6



After calibration is done, go to the feeder, follow STEP 9-13 of "Loading Media for Continuous Printing" to finish loading process.

You are now ready to add a label image and print a die-cut label.

4 Printing

4.1 Selecting a Media ID

STEP 1 of 2

File **Media** Nesting Variable Data Banner Cost Report Options

Click **Media** from the toolbar.

STEP 2 of 2

iSys Certified Media

Paper Plastic Foil

Glossy **Matte** Semigloss Tag Texture Piggyback Fluorescent

Media ID	Media Description	Media Vendor	Media Type	Media Weight
11001 - Matte White Paper	MACjet Ink Jet	MacTac	Plain	Ultra Heavy 1
11018 - Matte White Paper	Latex Impregnated RR22 3.2 mil. Hi-White Kraft	UPM Raflatac	Plain	Ultra Heavy 1
11019 - Matte White Paper	Matte Laser RP54 3.2 mil. Hi-White Kraft	UPM Raflatac	Plain	Ultra Heavy 1
11020 - Matte White Paper	54# Laser RP51 3.2 mil. Hi-White Kraft	UPM Raflatac	Plain	Ultra Heavy 1
11021 - Matte White Paper	40# Jetlite RP54 3.2 35# White Kraft (2.2 mil.)	UPM Raflatac	Plain	Ultra Heavy 1
11022 - Matte White Paper	50# Jetlaser RP54 2.8mil White Kraft	UPM Raflatac	Plain	Ultra Heavy 1
11023 - Matte White Paper	Jetcolor RP54 2.8 mil White Kraft	UPM Raflatac	Plain	Ultra Heavy 1
11024 - Matte White Paper	50# Laser Plus RP54 2.8 mil White Kraft	UPM Raflatac	Plain	Ultra Heavy 1
11025 - Matte White Paper	Jetlaser Translucent RR22 3.2 mil Hi-White Kraft	UPM Raflatac	Plain	Ultra Heavy 1
11026 - Matte White Paper	Matte Litho RP51 40# White Kraft	UPM Raflatac	Plain	Ultra Heavy 1
11027 - Matte White Paper	Jetlaser Translucent RP54 3.2 mil Hi-White Kraft	UPM Raflatac	Plain	Ultra Heavy 1
11028 - Matte White Paper	Fasson Uncoated Litho WS/AT20N/1.2M PET	Avery Dennison	Plain	Heavy

The media list will open. It contains medias that have been certified by UniNet. You can select one from the list by double click.

4.2 How to Create a New Media ID

STEP 1 of 5

File **Media** Nesting Variable Data Banner Cost Report Options

To create a new media, click the **Media** tab on the toolbar.

STEP 2 of 5

iSys Certified Media					
Paper Plastic Foil					
Glossy Matte Semigloss Tag Texture Piggyback Fluorescent					
Media ID	Media Description	Media Vendor	Media Type	Media Weight	
11001 - Matte White Paper	MACjet Ink Jet	MacTac	Plain	Ultra Heavy 1	
11018 - Matte White Paper	Latex Impregnated RR22 3.2 mil. Hi-White Kraft	UPM Rafiatac	Plain	Ultra Heavy 1	
11019 - Matte White Paper	Matte Laser RP54 3.2 mil. Hi-White Kraft	UPM Rafiatac	Plain	Ultra Heavy 1	
11020 - Matte White Paper	54# Laser RP51 3.2 mil. Hi-White Kraft	UPM Rafiatac	Plain	Ultra Heavy 1	
11021 - Matte White Paper	40# Jetlitho RP54 3.2 35# White Kraft (2.2 mil.)	UPM Rafiatac	Plain	Ultra Heavy 1	
11022 - Matte White Paper	50# Jetlaser RP54 2.8mil White Kraft	UPM Rafiatac	Plain	Ultra Heavy 1	
11023 - Matte White Paper	Jetcolor RP54 2.8 mil White Kraft	UPM Rafiatac	Plain	Ultra Heavy 1	
11024 - Matte White Paper	50# Laser Plus RP54 2.8 mil White Kraft	UPM Rafiatac	Plain	Ultra Heavy 1	
11025 - Matte White Paper	Jetlaser Translucent RR22 3.2 mil Hi-White Kraft	UPM Rafiatac	Plain	Ultra Heavy 1	
11026 - Matte White Paper	Matte Litho RP51 40# White Kraft	UPM Rafiatac	Plain	Ultra Heavy 1	
11027 - Matte White Paper	Jetlaser Translucent RP54 3.2 mil Hi-White Kraft	UPM Rafiatac	Plain	Ultra Heavy 1	
11028 - Matte White Paper	Fasson Uncoated Litho WS/AT20N/1.2M PET	Avery Dennison	Plain	Heavy	

In the pop-up window above, select the base media for your new media and **right click** on the **Media ID**.

STEP 3 of 5

The dialog box 'Create & Update User Media' contains the following fields and options:

- Media Selected : 11001 - Matte White Paper
- Media ID : based on 11001 -
- Media Description : [Empty]
- Media Vendor : [Empty]
- Media Type : Plain (selected from a list including Letterhead, Bond, Recycled)
- Media Weight : Ultra Heavy 1 (selected from a list including Medium Light, Medium, Heavy)
- Create This Media button

In the second screenshot, the fields are updated as follows:

- Media Selected : 11001 - Matte White Paper
- Media ID : based on 11001 - iSys_New_Matte
- Media Description : For iSys matte roll
- Media Vendor : iSys
- Media Type : Plain
- Media Weight : Ultra Heavy 1
- Create This Media button

Fill in the **Media ID**, **Media Description** and **Media Vendor**, select **Media Type** and **Media Weight** from the list, then click **Create This Media**.

STEP 4 of 5

iSys Certified Media

Paper Plastic Foil White Toner

Glossy **Matte** Semigloss Tag Texture Piggyback Fluorescent

Media ID	Media Description	Media Vendor	Media Type	Media Weight
11001 - Matte White Paper	MACjet Ink Jet	MacTac	Plain	Ultra Heavy 1
11007 - Matte White Paper	Fasson LaserCopy Jet 300/S9010N/46#LF	Avery Dennison	Plain	Ultra Heavy 1
11018 - Matte White Paper	Latex Impregnated RR22 3.2 mil Hi-White Kraft	UPM Raflatac	Plain	Ultra Heavy 1
11019 - Matte White Paper	Matte Laser RP54 3.2 mil Hi-White Kraft	UPM Raflatac	Plain	Ultra Heavy 1
11020 - Matte White Paper	54# Laser RP51 3.2 mil Hi-White Kraft	UPM Raflatac	Plain	Ultra Heavy 1
11022 - Matte White Paper	50# Jetlaser RP54 2.8 mil White Kraft	UPM Raflatac	Plain	Ultra Heavy 1
11023 - Matte White Paper	Jetcolor RP54 2.8 mil White Kraft	UPM Raflatac	Plain	Ultra Heavy 1
11024 - Matte White Paper	50# Laser Plus RP54 2.8 mil White Kraft	UPM Raflatac	Plain	Ultra Heavy 1
11026 - Matte White Paper	Matte Litho RP51 40# White Kraft	UPM Raflatac	Plain	Ultra Heavy 1
11027 - Matte White Paper	Jetlaser Translucent RP54 3.2 mil Hi-White Kraft	UPM Raflatac	Plain	Ultra Heavy 1
11028 - Matte White Paper	Fasson Uncoated Litho WS/AT20N/1.2M PET	Avery Dennison	Plain	Heavy
based on 11001 - iSys_New_Matte	For iSys matte roll	iSys	Plain	Ultra Heavy 1

Your new media will be displayed in the list.

NOTE: UniNet provides a variety of substrates that have been rigorously tested for optimal print quality, ease of use and consistency from the beginning of the job until the end. The iColor 700 was designed and engineered to operate with approved consumables and certified media which ensure superior quality and resolution every time. UniNet is not responsible for damage or consequences arising from the use of non-certified media or consumables.

STEP 5 of 5

iSys Certified Media

Paper

Matte

Media ID	Media Description	Media Vendor	Media Type	Media Weight
based on 11001 - iSys_New_Matte	For iSys matte roll	iSys	Plain	Ultra Heavy 1

based on 11001 - iSys_New_Matte Show Only User Media

There is an option that allows for only the new media to be displayed. Check the **Show Only User Media** box to view only new/custom media IDs.

4.3 Editing a Newly Created Media ID

STEP 1 of 2

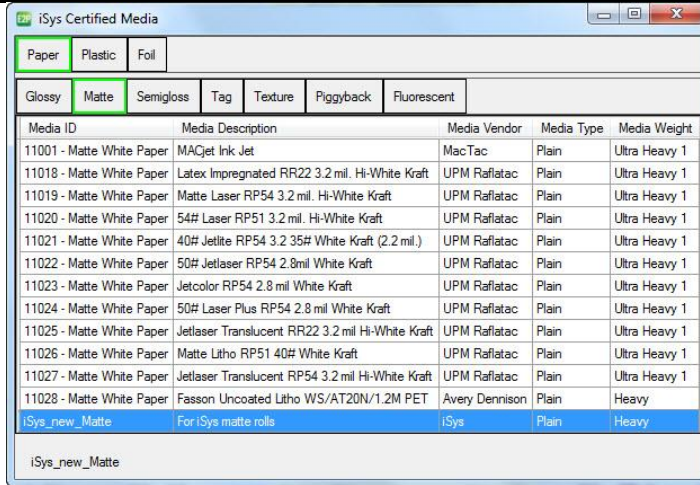

If the new media needs to be edited, right click on the new Media ID.

STEP 2 of 2

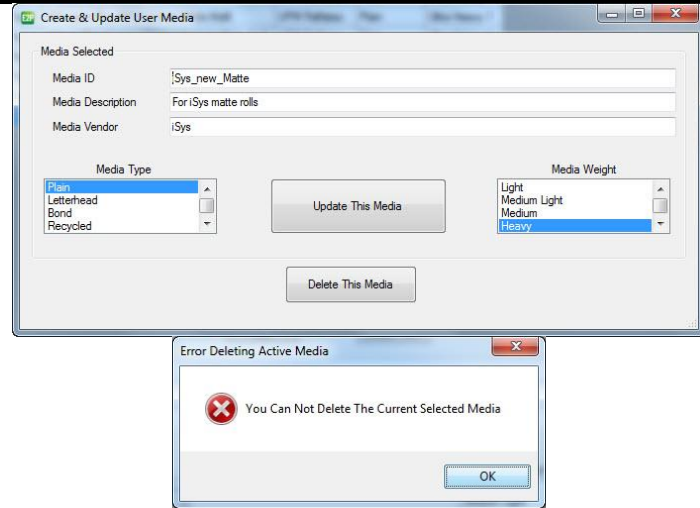

This window will allow you to edit. After editing, click **Update This Media** button to update the information. If you want to delete it, click **Delete This Media** button.

NOTE: You can only delete the media you created. The certified medias in the library can't be deleted. You can't delete the media that is currently been selected, or an error will be displayed.

4.4 Adding Label Images to Print

STEP 1 of 5

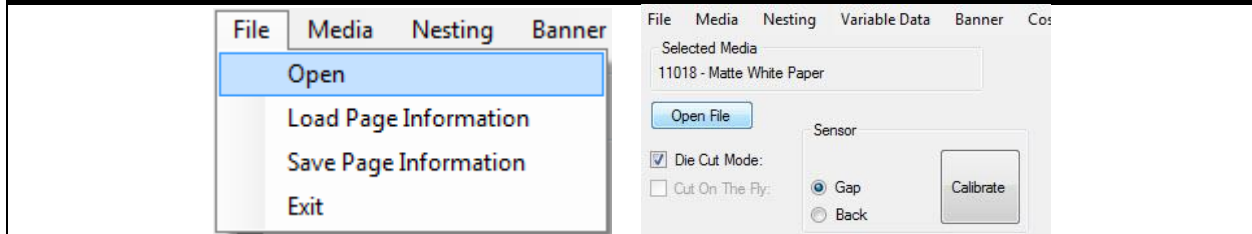

To open a file, choose **File**→**Open**, or click **Open File** button to select your PDF file, or you can simply drag and drop your PDF file to the **Preview Screen**.

NOTE: EDGE2Print uses PDF files only. Under Windows 8, drag and drop doesn't work.

STEP 2 of 5



You can load multiple PDF files as long as they have the same dimensions, but the number of PDF files shouldn't exceed the column numbers on the die cut media. The images will show in the **Preview Screen**, and multiple files are aligned in columns.

STEP 3 of 5

Remove	File Name	Toner Cost
Delete	Salad_1	0.03910
Delete	Salad_2	0.02356
Delete	Salad_3	0.03384

The information of the images will show in the **Image List** on the left.

STEP 4 of 5

Print: 1.453 feet

Labels to Print:

Enter how many labels you want to print. EDGE2Print will automatically round the amount of labels up to complete a full row. Then click **Print** to start printing labels.

NOTE: If you loaded multiple PDF files, the copy number indicates the amount of each PDF file.

STEP 5 of 5

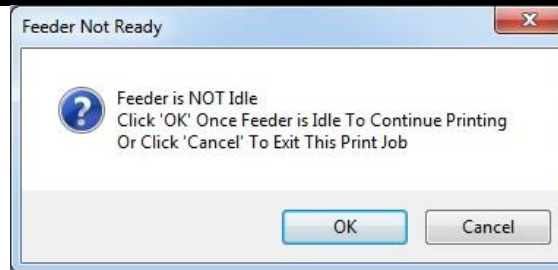

If the feeder panel doesn't read **Status: Idle**, a message will show. Please go the feeder to load the media and get the feeder to the idle status and click **OK** to continue printing.

4.5 Adjusting the Print Alignment

STEP 1 of 4

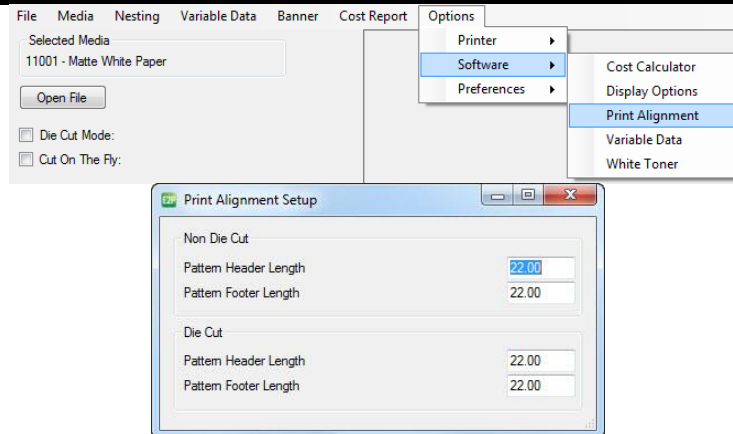

Select **Options**→**Software**→**Print Alignment** from the toolbar. Set the proper **Pattern Header Length** and **Pattern Footer Length**.

NOTE: For every print job, you need to adjust vertically where the printer starts printing the label images.

Recommendation: The header needs to be 22 inches or longer in order to adjust the color registration. The footer can be set to 0 without affecting the color registration.

STEP 2 of 4



Check the start position. The 22 inches of header color patterns are used for calibration. The gap between labels should be in line with the gap on the label line. If the labels are not aligned after the third copy, adjust the start position value according to how far the label is from the gap.

STEP 3 of 4

Page Information : Inches

Start Position (-/+):	0.000
Media Width:	8.169
Horizontal Shift (-/+):	0.000
Gutter:	0.125
Alley:	0.125

Apply

Start Position
Positive Value (+): Move print down
Negative Value (-): Move print up

STEP 4 of 4

Page Information : Millimeters

Start Position:	0.000
Media Width:	210.000
Horizontal Shift (-/+):	0.000
Gutter:	3.200
Alley:	3.200

Apply

We can also use Horizontal Shift(-/+) to make adjustment to the labels.
Positive Value (+): Move print right
Negative Value (-): Move print left

4.6 Nesting

Nesting is a feature where users can print multiple graphics of the same size and layout in a sequence without stopping.

For example, you have three salad labels of the same size and need 10 Mediterranean, 5 Berry Blue and 25 Field Berry for one run. Rather than printing these individually, you can print them all in the same run, one after another without stopping. By using the nesting feature you will save time of setting up the job and save media by using one header and footer rather than three.

STEP 1 of 4

Click **Nesting** on the Toolbar. Notice that the **Add** and **Edit** buttons have become available and the **Print** button is now labeled **Print Nesting**.

STEP 1 of 4

Load the PDF file/files and enter the number you want to print. Then click **Add** and job will be saved for printing and the images will disappear from the Preview Screen. The **Print Nesting** button will now display **Print Nesting: 1**

STEP 3 of 4

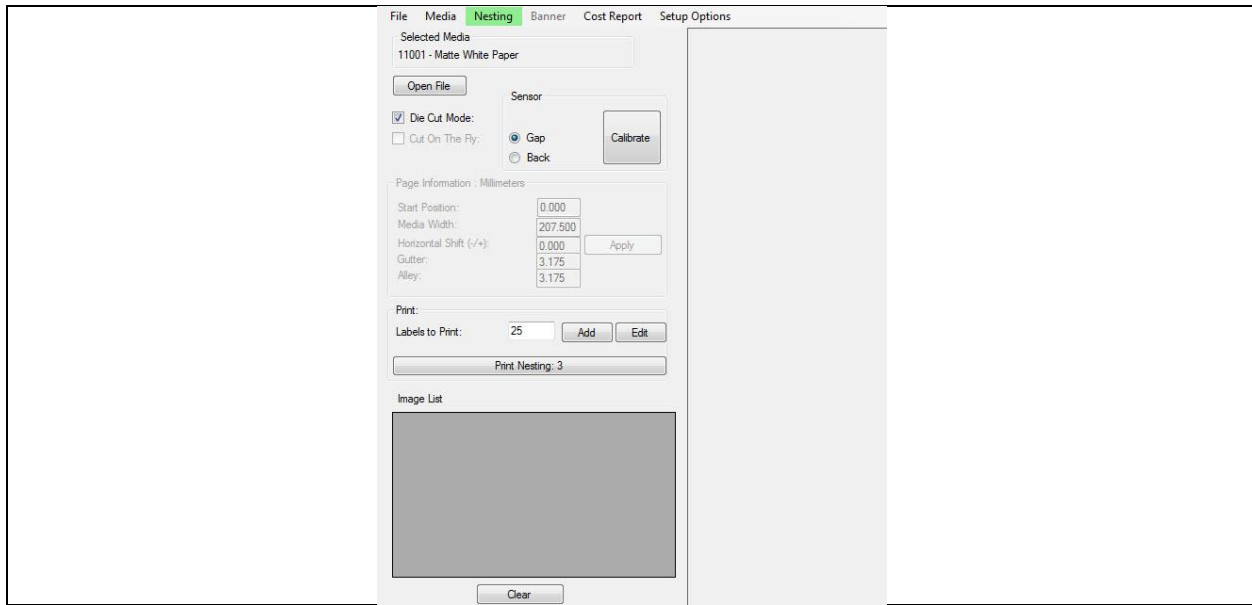

Repeat the above step until all the printing jobs are loaded. For example, we have 3 jobs loaded, **Print Nesting: 3** will be displayed. Click that, and the printing process will start right away.

STEP 4 of 4

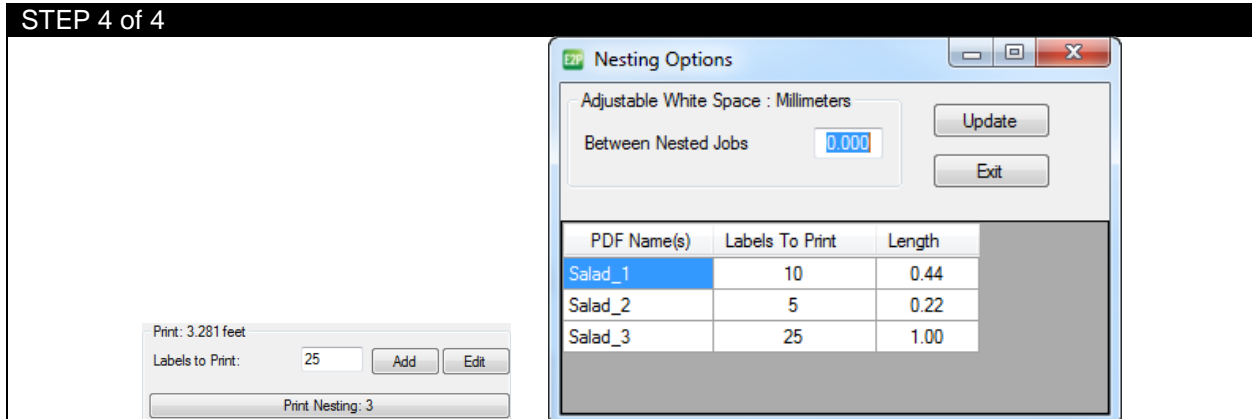

If you need to edit the nesting job, click **Edit** button and the option window will pop up. You can add white space between nested. Label quantity can also be adjusted across each nested job. Once the necessary changes have been made, click **Update** then click **Exit** to return.

4.7 How to Activate Variable Data (iVDP)

STEP 1 of 4

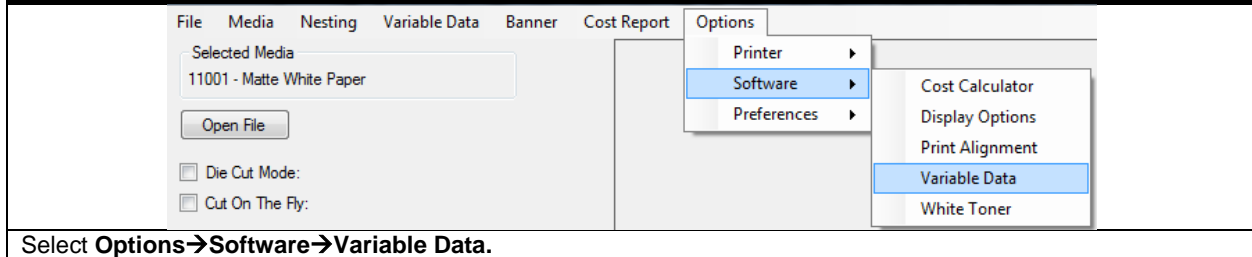

Select **Options**→**Software**→**Variable Data**.

STEP 2 of 4

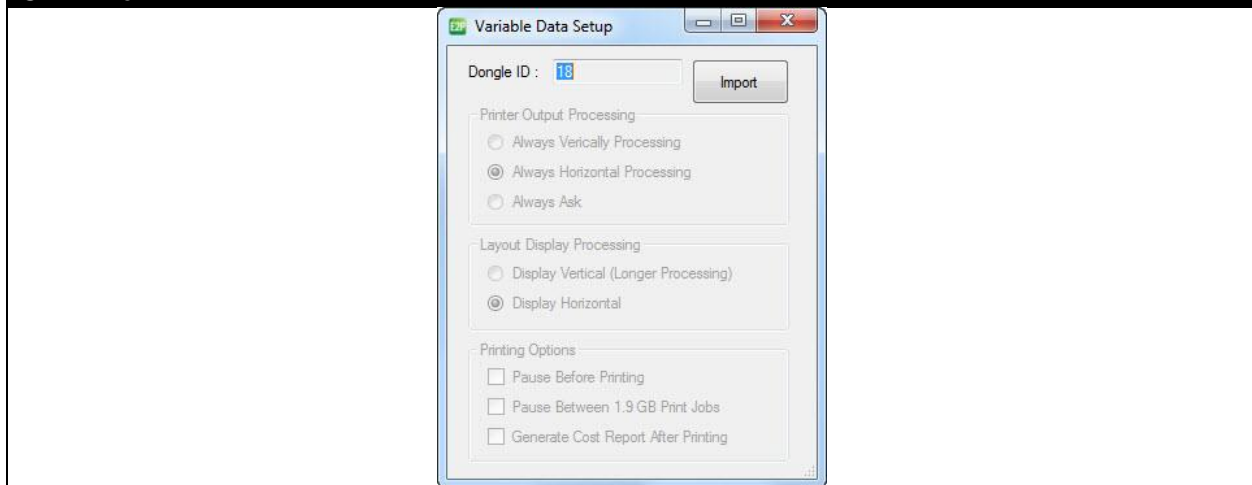

Make sure the **Dongle ID** is correct and click **Import**.

STEP 3 of 4

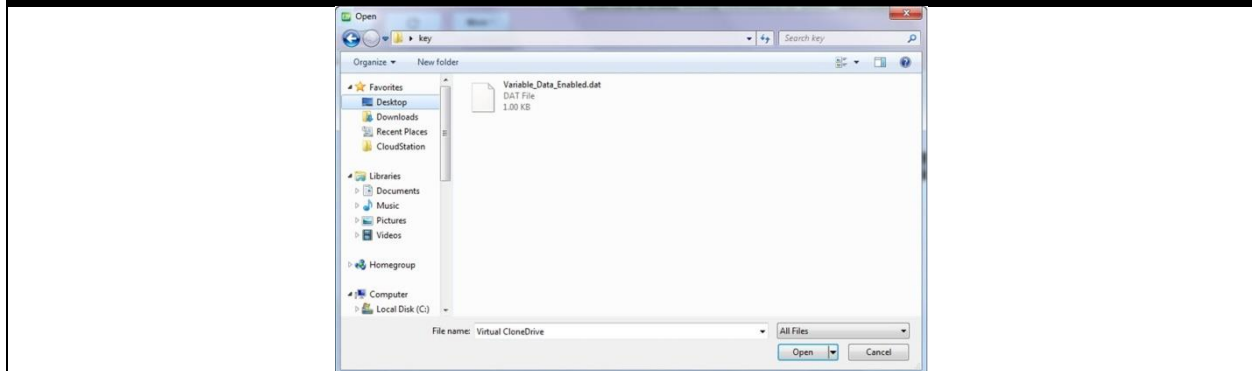

Open the folder that holds the Key and select **Variable_Data_Enabled.dat**, then select **Open**.

STEP 4 of 4

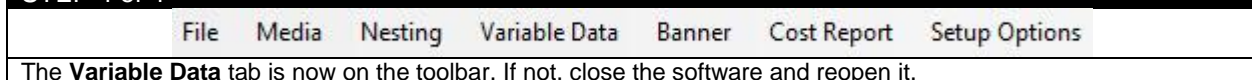

The **Variable Data** tab is now on the toolbar. If not, close the software and reopen it.

4.8 Printing Variable Data

STEP 1 of 5

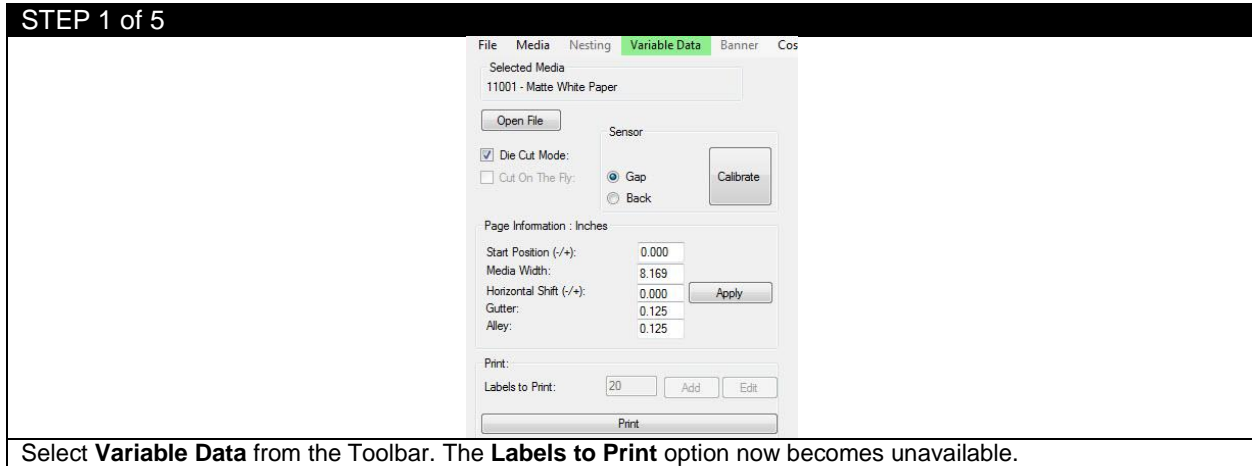

Select **Variable Data** from the Toolbar. The **Labels to Print** option now becomes unavailable.

STEP 2 of 5

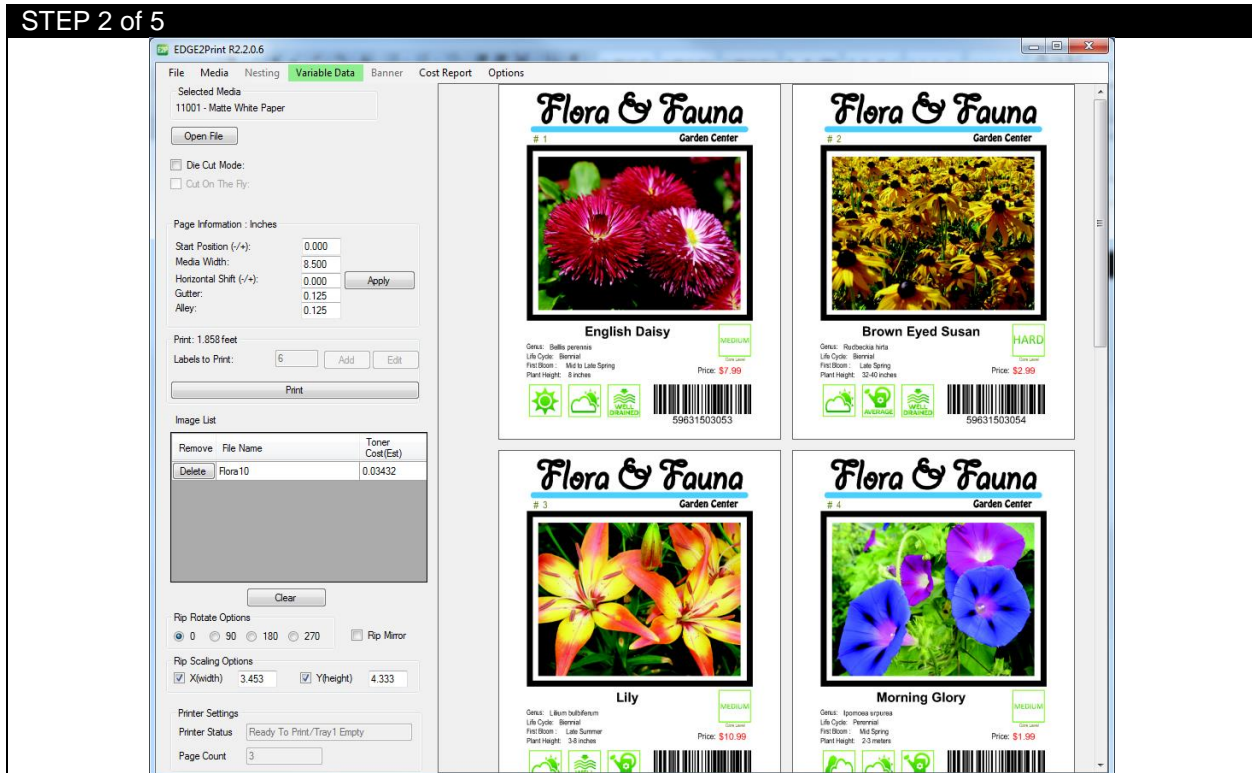

Open the PDF file that contains your variable data. Once loaded, click the **Print** button.

Important: If only the first image of your variable data is visible on the preview screen, then you did not click the **Variable Data** tab before you load the file. You should clear the file and redo STEP 1 & 2.

Limitations: Variable Data has a 1.9GB limitation. If the file is larger than 1.9GB, the software will divide the data into separate jobs of 1.9GB each.

STEP 3 of 5

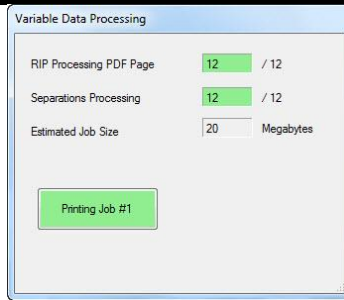

Once the **Print** button is clicked, this window will pop up. The RIP and Separations Processing will take a while to fully process depending on your hardware. Once they have processed, their screens will turn green and a **Printing Job #1** will appear.

STEP 4 of 5

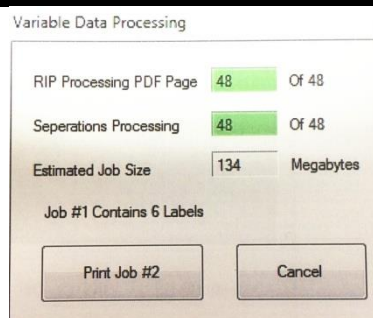

If the print job is larger than 1.9GB, and you selected **Pause** between 1.9GB print jobs option, this window will appear after the first job is printed and you must click **Print Job #2** to start printing the next job. If you did not select Pause between 1.9GB print jobs, then job #2 will automatically start printing. Please refer to STEP 5 for printing options.

STEP 5 of 5

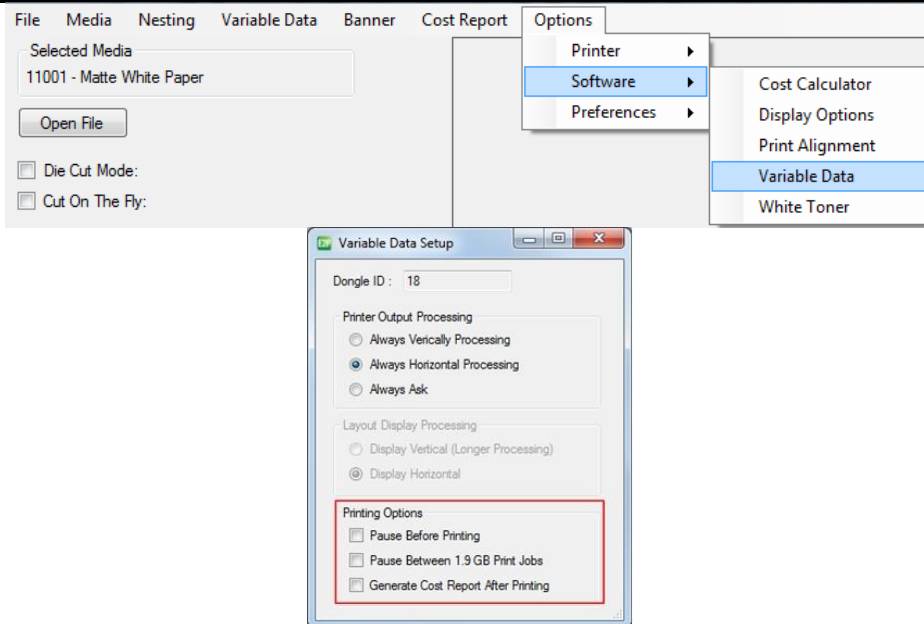

Click **Options->Software->Variable Data** from the toolbar, you will see the Options of variable data printing.

4.9 Printing Using Banner Mode

STEP 1 of 5

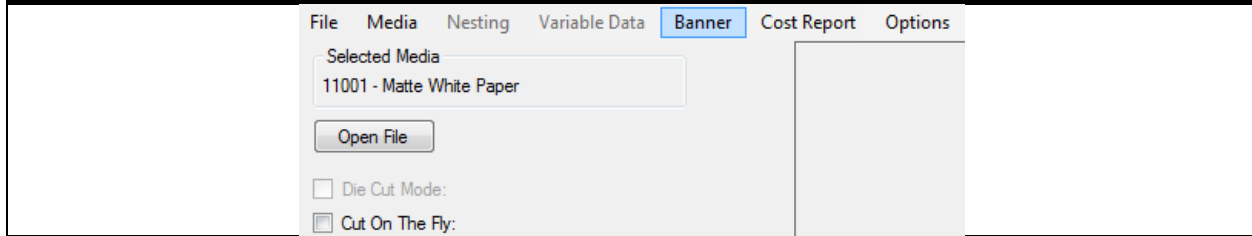

EDGE2Print has a feature which can print a long PDF file using the banner mode.

Select **Banner** from the toolbar. The **Die Cut Mode** now becomes unavailable.

STEP 2 of 5

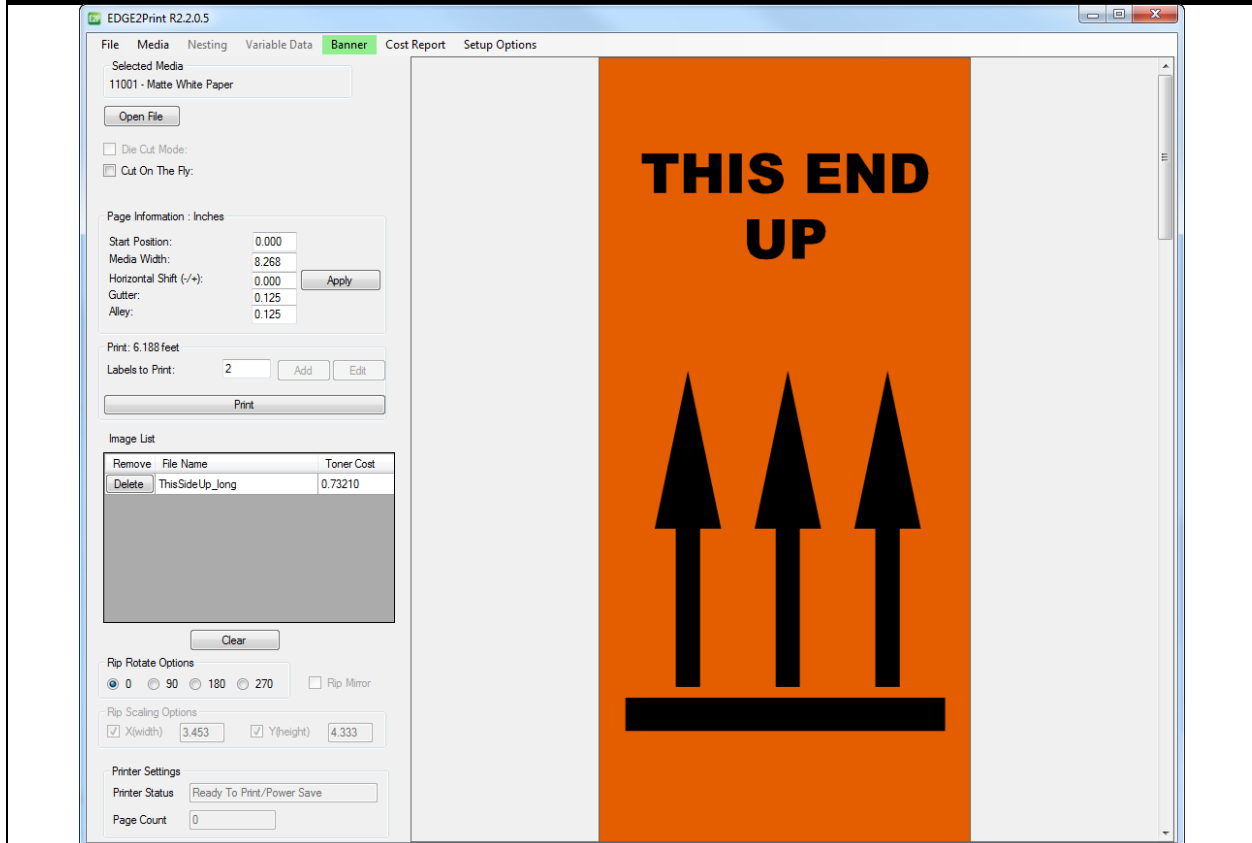

Load the PDF file into EDGE2Print.

STEP 3 of 5

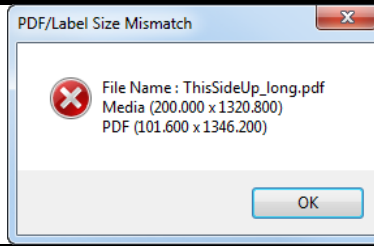

If this dialogue pops up, it means you did not click the **Banner** tab before you load your file. Please redo STEP 1 & 2.

STEP 4 of 5

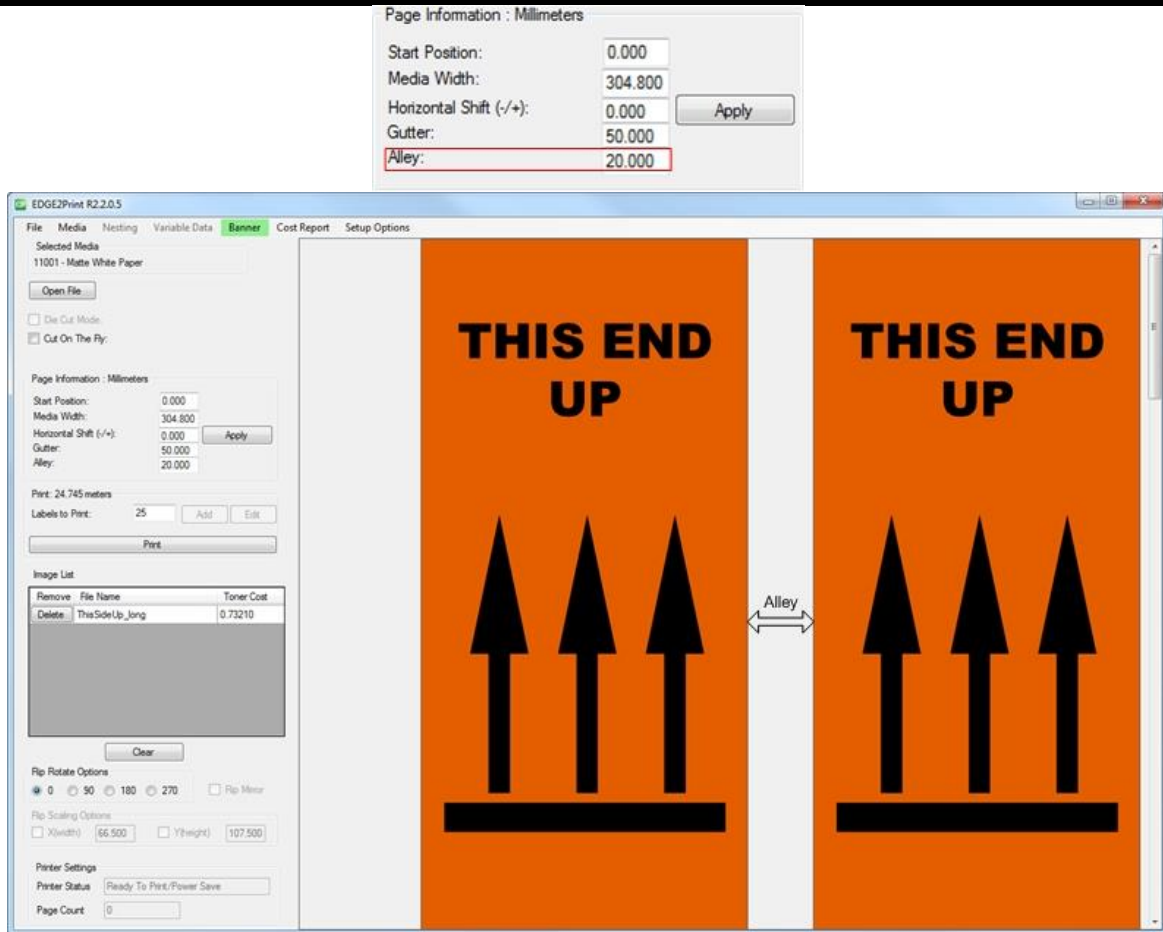

If the media width is large enough to take up multiple columns of the banner, it will show in multiple columns. You can set a value to the **Alley** to separate each column.

STEP 5 of 5

Page Information : Millimeters

Start Position:	0.000
Media Width:	304.800
Horizontal Shift (-/+):	0.000
Gutter:	50.000
Alley:	20.000

Apply

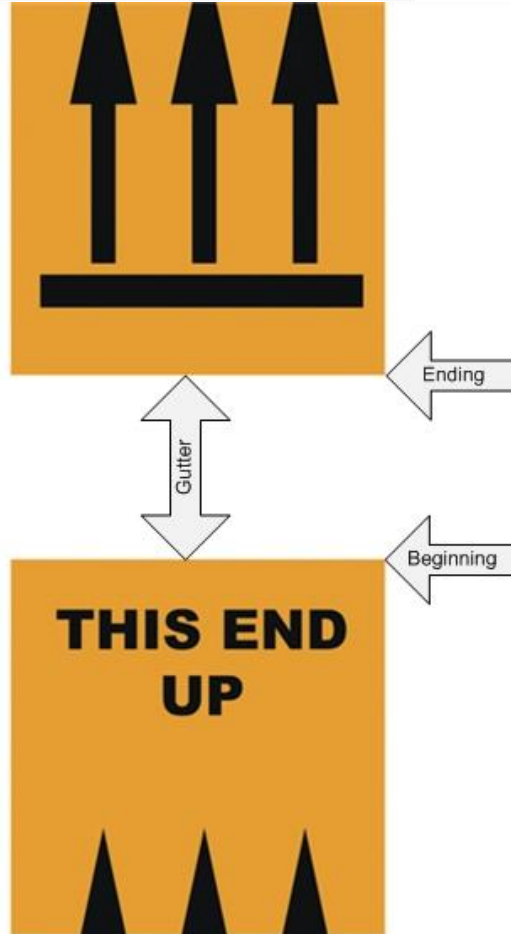

You can set a value to **Gutter** if you want a gap between multiple banners. The output of your banner will look like the layout above.

NOTE: The limitation of PDF size is 200 inches (5080 mm) long. If your graphic is larger than this, you will need to have your graphic designer create a multi-page PDF with 199 inches (5054.6 mm) sections or less. The multi-page PDF can now be imported into the software and printed in sequence.

4.10 How to Activate White Toner

EDGE2Print allows you to print white spot color and print white underneath the color for transparent media and black media.

STEP 1 of 7

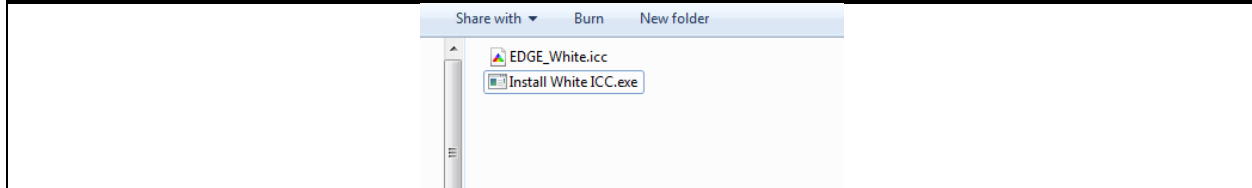

Install the ICC profile for using white toner first.
Open the folder of **Install White ICC**. Double click **Install White ICC.exe**.

STEP 2 of 7

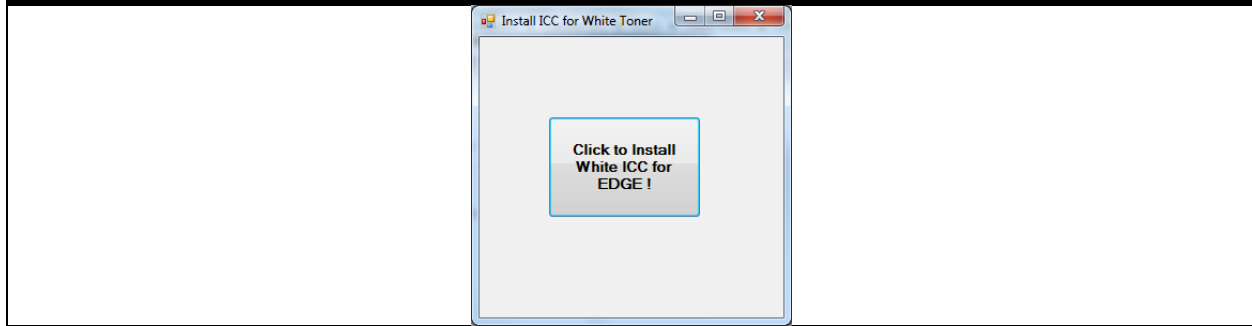

Click the button **Click to Install White ICC for EDGE!**

STEP 3 of 7

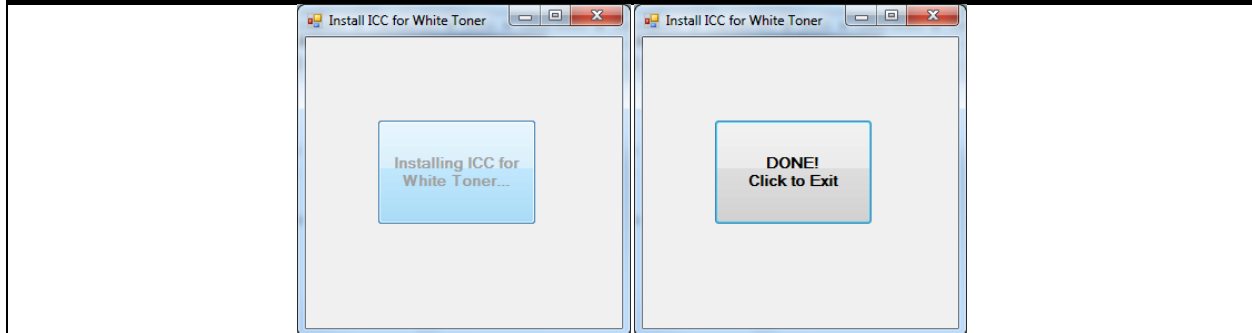

Wait until the process finishes. Close the window by click the center button.

STEP 4 of 7

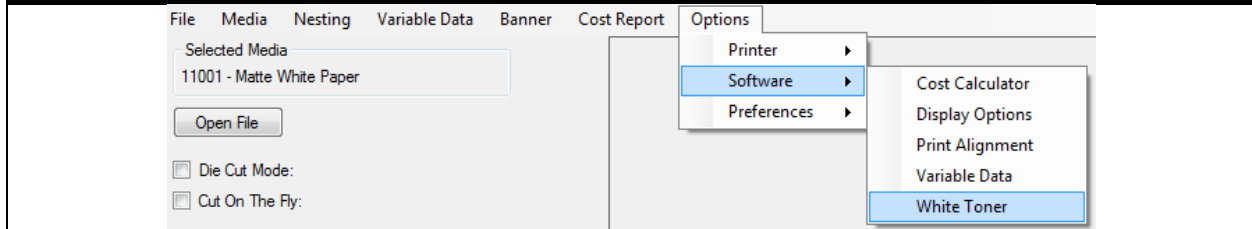

Go to Edge2Print, click **Options->Software->White Toner** from the toolbar.

STEP 5 of 7

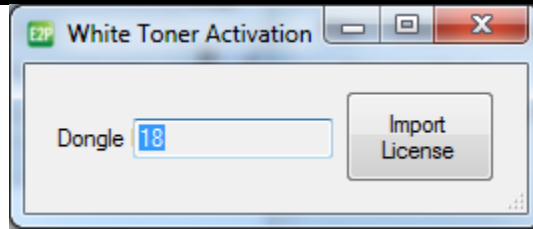

Click **Import License**.

STEP 6 of 7

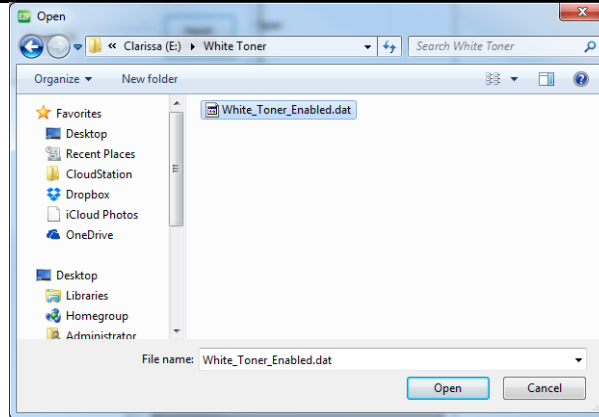

Open the folder that holds the Key and select **White_Toner_Enabled.dat**, then select **Open**.

STEP 7 of 7

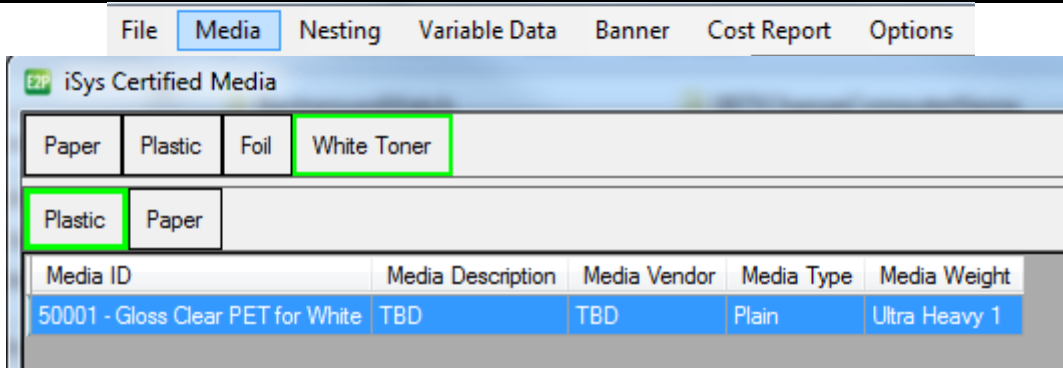

Now, click **Media** from the toolbar, you will see a **White Toner** tab with two categories **Plastic** and **Paper**.

4.11 Printing using White Toner

STEP 1 of 2

The screenshot shows the 'iSys Certified Media' selection window. It has tabs for 'Paper', 'Plastic', 'Foil', and 'White Toner'. The 'White Toner' tab is active. Below the tabs, there are sub-tabs for 'Plastic' and 'Paper'. A table lists media options:

Media ID	Media Description	Media Vendor	Media Type	Media Weight
50001 - Gloss Clear PET for White	TBD	TBD	Plain	Ultra Heavy 1

Below the table, the 'Selected Media' field shows '50001 - Gloss Clear PET for White' with a 'W' to its right. A button 'Open File' is visible, and a message box says 'Media for White Toner Selected'.

Select a media under **White Toner** category. You will see a "W" on the right side of the media name which indicate that the media for using white toner is selected.

STEP 2 of 2

The screenshot shows the 'EDGE2Print R2.2.0.6' software interface. The 'Selected Media' is '50001 - Gloss Clear PET for White' with a 'W'. The interface includes various settings like 'Page Information', 'Image List', and 'Printer Settings'. The main preview area shows four identical labels for 'Simply Fresh Field Berry Salad Kit'.

The printing process for white toner is the same as the normal one. It works for regular, nesting, variable data and banner modes.

Using Spot White

NOTE: If you want to print white, the color MUST be spot White. The following is an simple instruction to change a color to spot White color in AI.

STEP 1 of 4

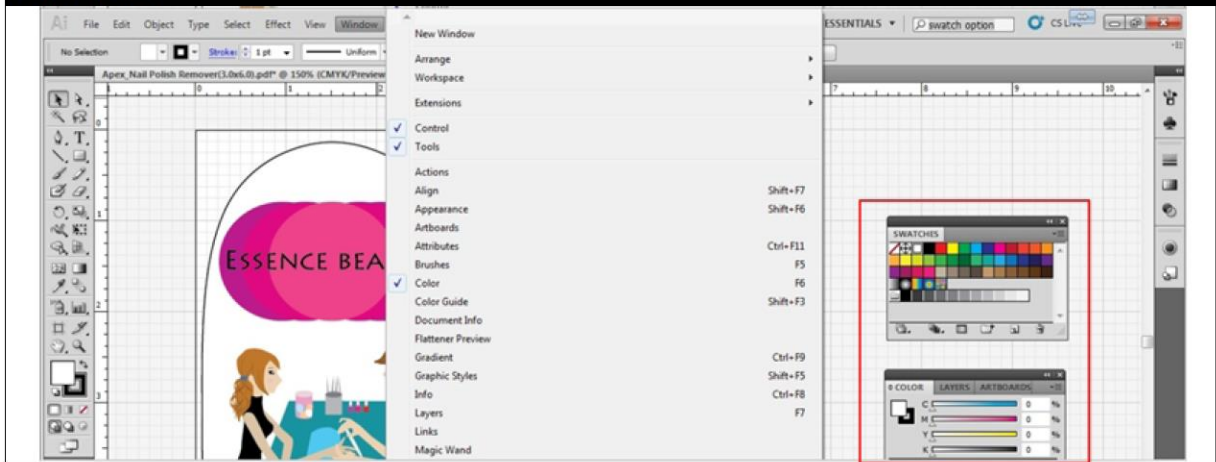

Open you file in AI. Click **Window->Color** and **Window->Swatches** to show COLOR and SWATCHES windows.

STEP 2 of 4

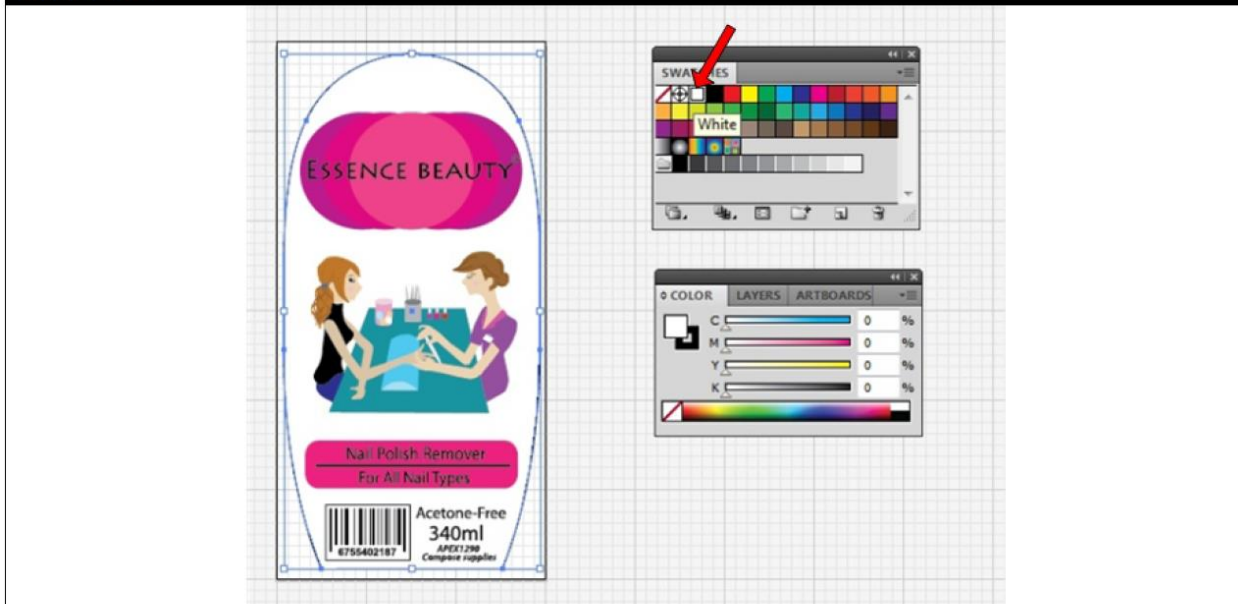

Select the area you want to print white, then double click **White** on SWATCHES.

STEP 3 of 4

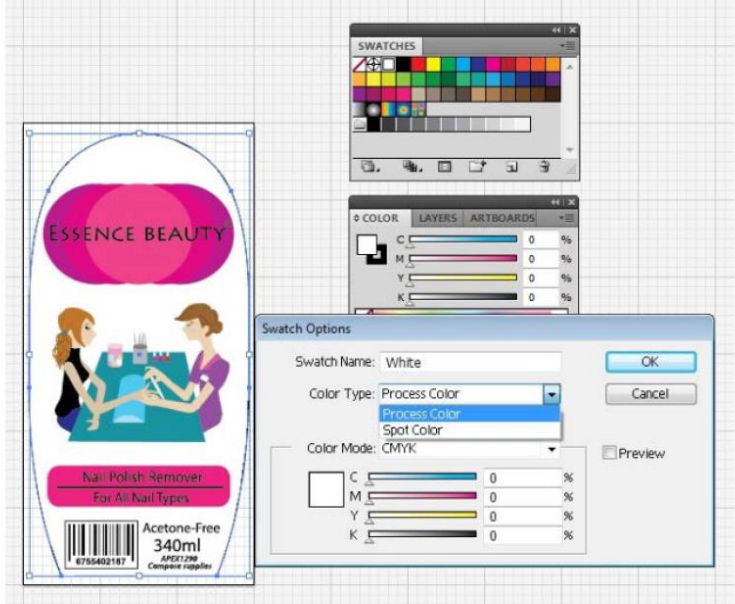

Change the **Color Type** from **Process Color** to **Spot Color**. Then click OK.

NOTE: Make Sure the Swatch Name is "White"! It is very Import!

STEP 4 of 4



Now you have spot white for selected area. You can tell from the **COLOR window** which shows **White 100%**. Repeat Step 3 and 4 for all area you want to be spot white and save the file.

4.12 How to Set Up the Rewinder

STEP 1 of 6



Loosen the **Core Adjustment Knob**. Place a core on the **Rewinder Spindle**. Make sure the core is the same width of the media you're printing on or slightly smaller. If the core is the exact same width as the media, ensure it is placed flush against the left end disk. If the core is slightly smaller, place it in the center using your best judgment.

STEP 2 of 6



Cut a section of the media you'll be using to print. Place that piece of media flush against the **Left End Disk** and adjust the **Right End Disk** to fit the media. Ensure that the paper is flat against the core and there is no excess space on each side of the **End Disks**. Tighten the **Core Adjustment Knob**.

NOTE: If there is excess space between the core and the Left/Right End Disks OR the media is not flat against the core, it will cause the roll to wind haphazardly, not wind tightly and create bubbles in the roll.

STEP 3 of 6



Loosen the **Lockdown Knob** for positioning. When you are ready to print, send a small section of labels to the printer. While the section is printing, adjust the retractor left/right using the **Width Adjustment Knob**, aligning the retractor with the paper path as the labels exit the machine. Once the paper path and retractor are aligned, tighten the **Lockdown Knob**.

STEP 4 of 6



Plug the **DC Power In**, and then plug the end of the power cord into a socket. Turn the retractor on by turning the switch to **REV**.

STEP 5 of 6

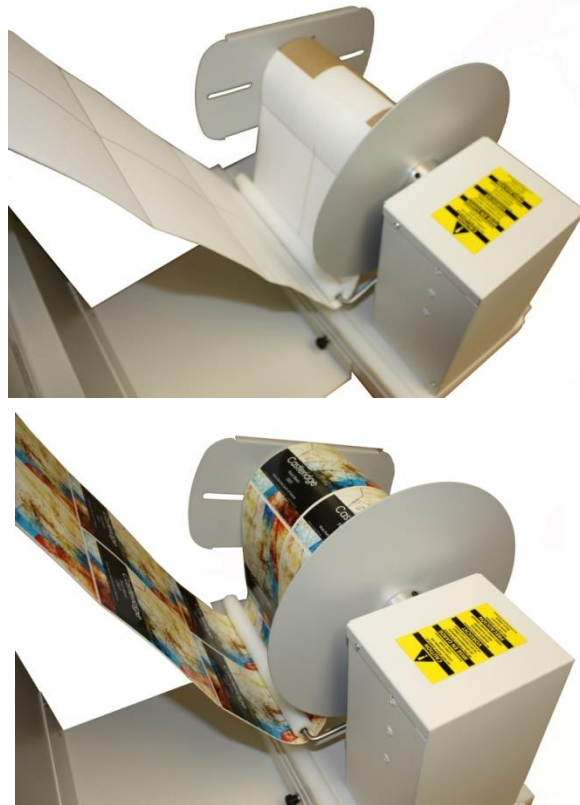

Press Print in the software when your job is ready. As the paper exits the printer, lift the **Dancer Arm** and bring the media underneath the **Dancer Arm** and up onto the core. Secure it to the core using a section of media or excess label.

Lower the **Dancer Arm** downwards to begin winding the material onto the core. Place your hand gently on top of the core to create some initial tension at the beginning of the roll. Once the media is winding, release the **Dancer Arm** gently downwards onto the paper. The roll will continue to wind.

NOTE: Winding speed is determined by the position of the **Dancer Arm**. Lowering the arm will speed up the winding and lifting upwards will slow it down.

NOTE: If the roll seems to be winding too loosely, place your hand on the top of the roll while it's winding. This will increase the tension momentarily. Be careful when doing this as too much tension will cause the roll to wind unevenly or create bubbles between the reams.

STEP 6 of 6



When the roll is done, turn off the rewinder. Unscrew the **Core Adjustment Knob** on the **Spindle**. Remove the roll from the **Spindle** and return the **Right End Disk** to its initial position.

5 Software Features and Options

5.1 How To Print a Full Bleed Die Cut Label

The following is a detailed guide to create an oversized label image on top of a die cut label. The term over bleed means that there is a small portion outside of the actual label known as the “overprint area”. Excess toner of the label is printed on to this area so that the actual dimensions of the label are met with clear, clean cut edges. The cutting is done after we print.

WARNING: Print full bleed die cut label may damage the consumables!

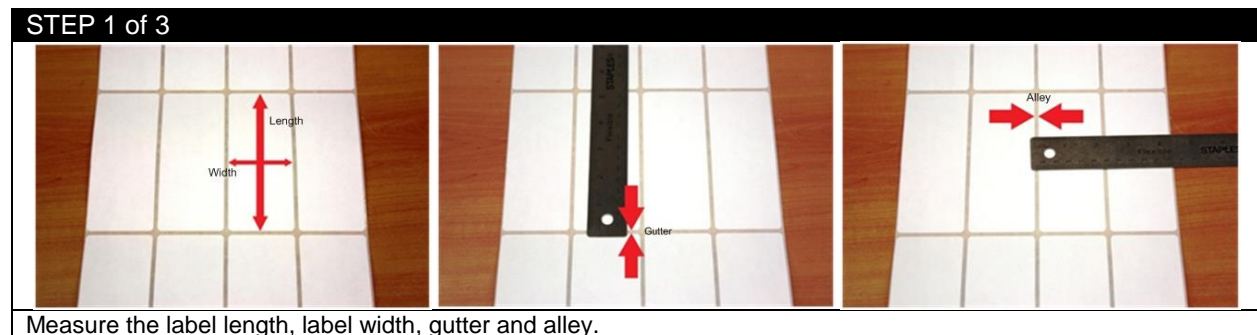

STEP 2 of 3

<p>Rip Scaling Options</p> <p><input checked="" type="checkbox"/> X(width) 50.500 <input checked="" type="checkbox"/> Y(height) 127.000</p>	<p>Page Information : Millimeters</p> <p>Start Position: 0.000</p> <p>Media Width: 215.900</p> <p>Horizontal Shift (-/+): 0.000</p> <p>Gutter: 3.175</p> <p>Alley: 3.175</p> <p>Apply</p>
---	---

Input the number into proper place. For example, the label width(X) is 50.5mm, label height(Y) is 127mm, gutter is 3.175mm, alley is 3.175mm.

STEP 3 of 3

<p>Rip Scaling Options</p> <p><input checked="" type="checkbox"/> X(width) 52.500 <input checked="" type="checkbox"/> Y(height) 129.000</p>	<p>Page Information : Millimeters</p> <p>Start Position: 0.000</p> <p>Media Width: 215.900</p> <p>Horizontal Shift (-/+): 0.000</p> <p>Gutter: 1.175</p> <p>Alley: 1.175</p> <p>Apply</p>
---	---

If you want to print 1mm bleed outside of the label size on both direction, just minus gutter and alley by 2mm, and add 2mm to width and height. So width becomes 52.5mm, height becomes 129mm, gutter becomes 1.175mm and alley becomes 1.175mm.

5.2 Install Your Own ICC Profile

STEP 1 of 8

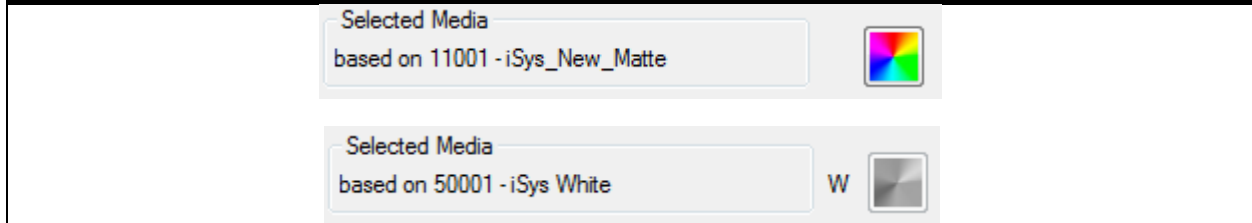

When you are using the created media, you can install your own ICC profile. Click the colourful square button on the right side of your media's name.

NOTE: If the media is created under white toner category, you don't have the color management option.

TIP: If you have a three-column media and you want to compare three different color managements on the same sheet, you can do like this. Choose one ICC profile for your label, load it into the software. Choose another ICC profile, load the same image into the software. Repeat this one more time, and click print, then you will have three columns of the same label but with different ICC profiles.

STEP 2 of 8

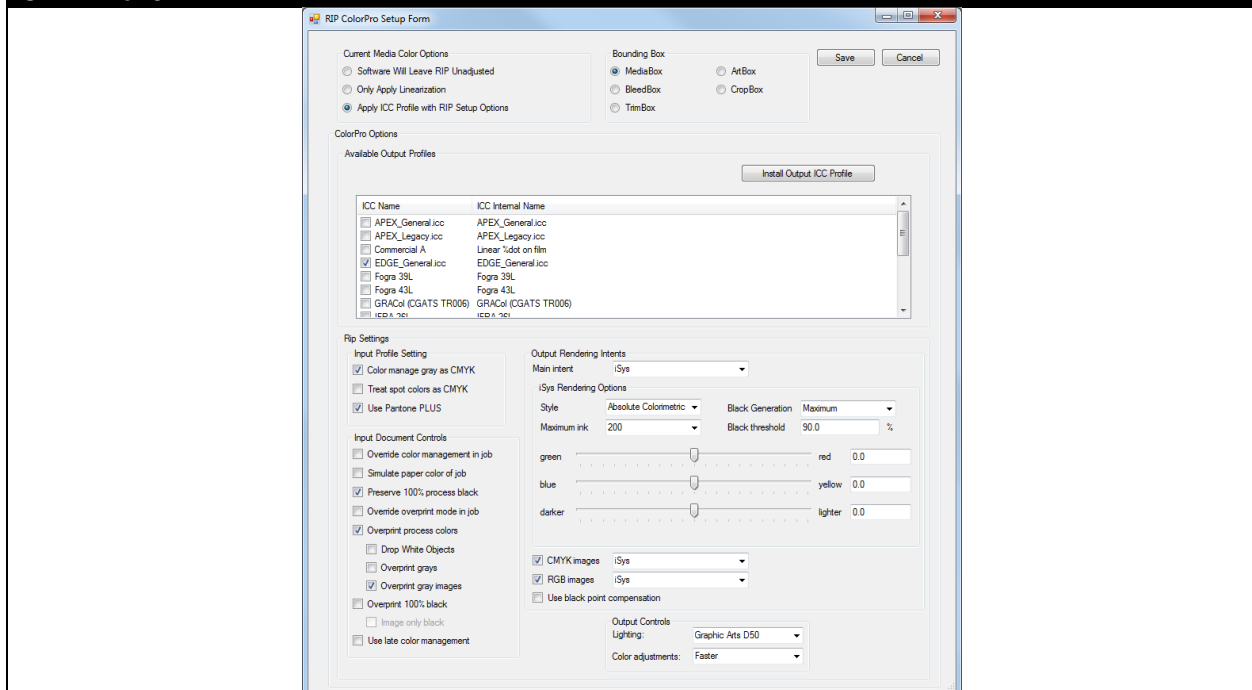

This dialogue allows you to setup your own color information. Make sure you checked **Apply ICC Profile with RIP Setup Options**.

STEP 3 of 8

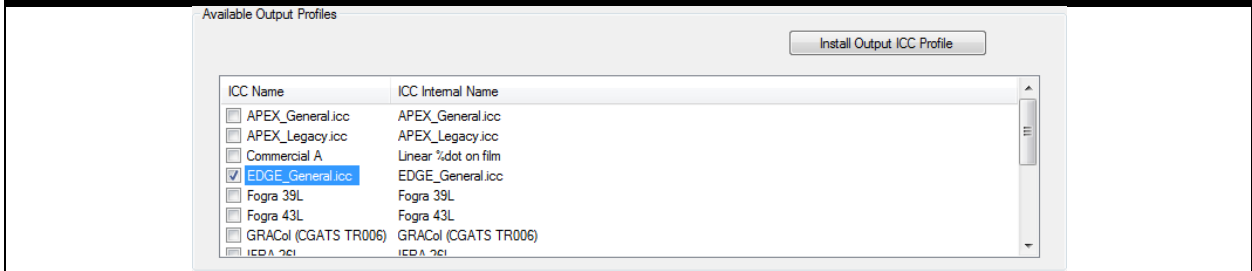

Click **Install Output ICC Profile**.

STEP 4 of 8

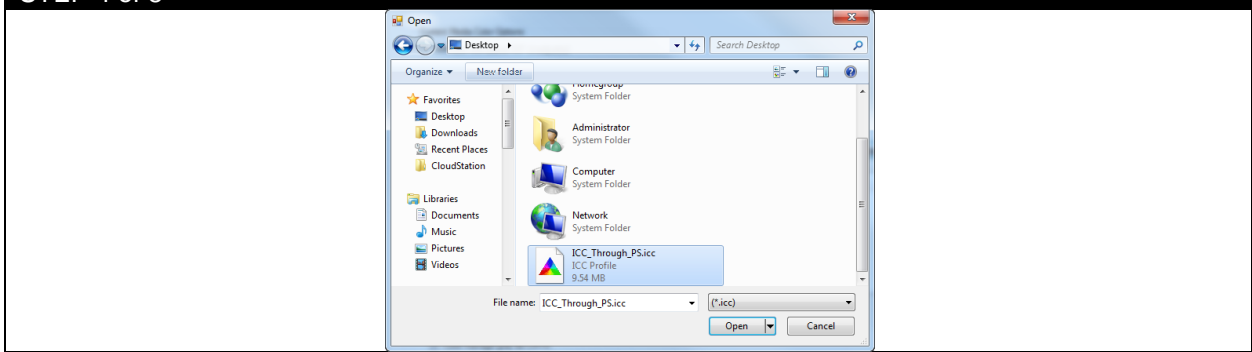

Select the ICC profile, click **Open**.

STEP 5 of 8

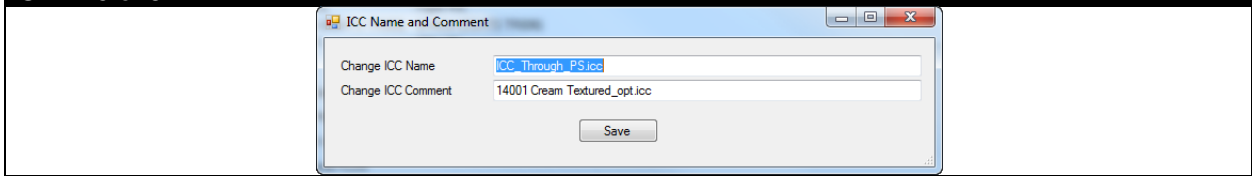

Change the ICC name and ICC comment if you need, then click **Save**.

STEP 6 of 8

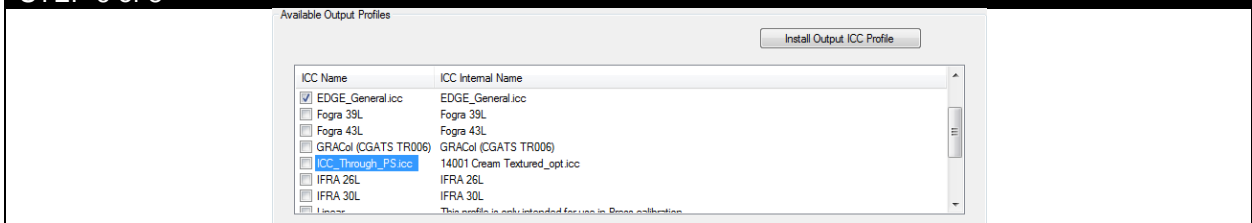

Then your ICC profile appears in the list.

STEP 7 of 8

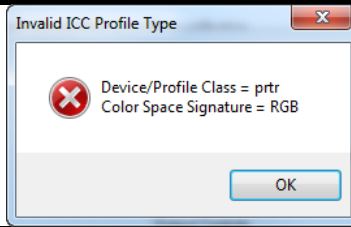

Notice that only CMYK ICC profile can be installed. If it is a RGB ICC profile, this window will pop up.

STEP 8 of 8

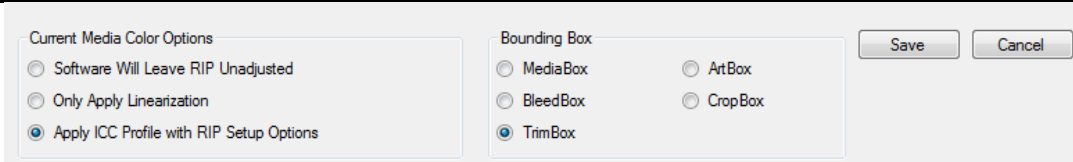

After making changes, click **Save** to save and close the dialogue.

5.3 RIP Settings

STEP 1 of 2

Selected Media
iSys_new_Matte



EDGE2Print has a feature to customize RIP settings for your labels if using own created media other than those under White Toner category.

Click the colourful square button on the right side of your media's name.

STEP 2 of 2

RIP ColorPro Setup Form

Current Media Color Options

Software Will Leave RIP Unadjusted

Only Apply Linearization

Apply ICC Profile with RIP Setup Options

Save Cancel

ColorPro Options

Available Output Profiles

Install Output ICC Profile

ICC Name	ICC Internal Name
<input type="checkbox"/> Commercial A	Linear %dot on film
<input checked="" type="checkbox"/> EDGE_General.icc	EDGE_General.icc
<input type="checkbox"/> Fogra 39L	Fogra 39L
<input type="checkbox"/> Fogra 43L	Fogra 43L
<input type="checkbox"/> GRACol (CGATS TR006)	GRACol (CGATS TR006)
<input type="checkbox"/> IFRA 26L	IFRA 26L
<input type="checkbox"/> IFRA 30L	IFRA 30L

Rip Settings

Input Profile Setting

Color manage gray as CMYK

Treat spot colors as CMYK

Use Pantone PLUS

Input Document Controls

Override color management in job

Simulate paper color of job

Preserve 100% process black

Override overprint mode in job

Overprint process colors

Drop White Objects

Overprint grays

Overprint gray images

Overprint 100% black

Image only black

Use late color management

Output Rendering Intents

Main intent: iSys

iSys Rendering Options

Style: Saturation Black Generation: Maximum

Maximum ink: 200 Black threshold: 90.0 %

green red 0.0

blue yellow 0.0

darker lighter 0.0

CMYK images iSys

RGB images iSys

Use black point compensation

Output Controls

Lighting: Graphic Arts D50

Color adjustments: Faster

Click **Apply ICC Profile with RIP Setup Options** on the top and you will see **RIP Settings** on the bottom. You can customize your RIP settings and click **Save** to save them.

NOTE: To apply the settings to your label images, you have to remove your file from the list and make the change of the setting, then reload the images again.

5.4 Installing the Fonts in the RIP

STEP 1 of 9

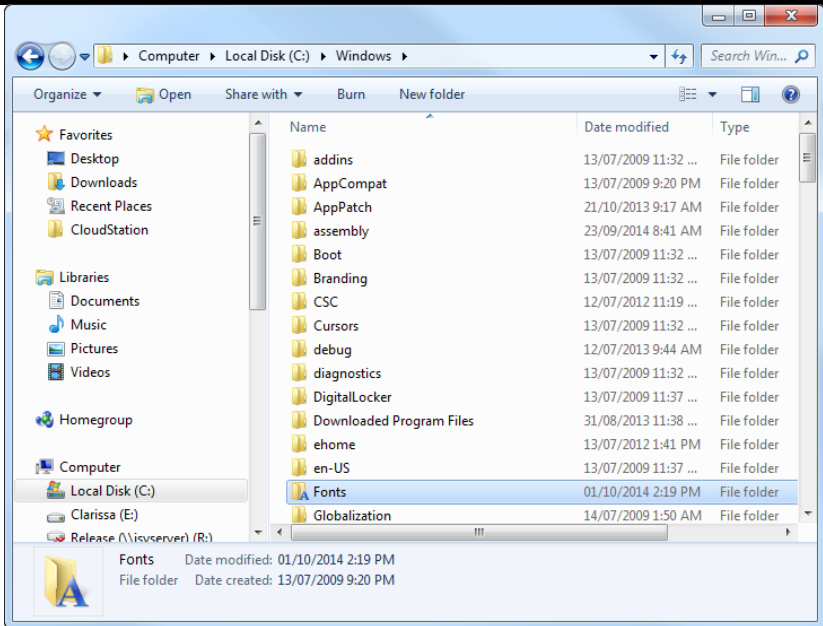

Go to **Computer**→**Disk(C:)**→**Windows**, double click **Fonts**.

STEP 2 of 9

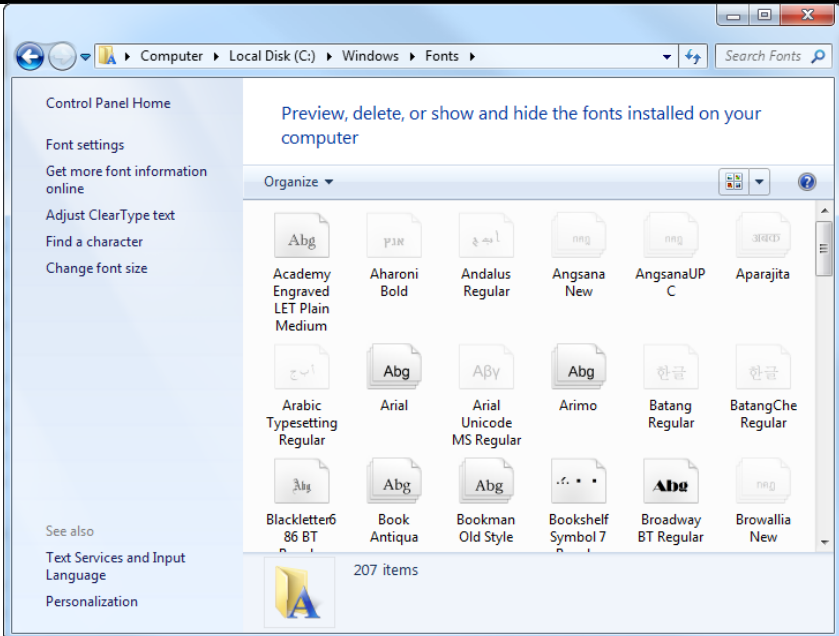

Press **Ctrl+A** to select all of the fonts within the folder, and press **Ctrl+C** to copy all of the fonts.

STEP 3 of 9

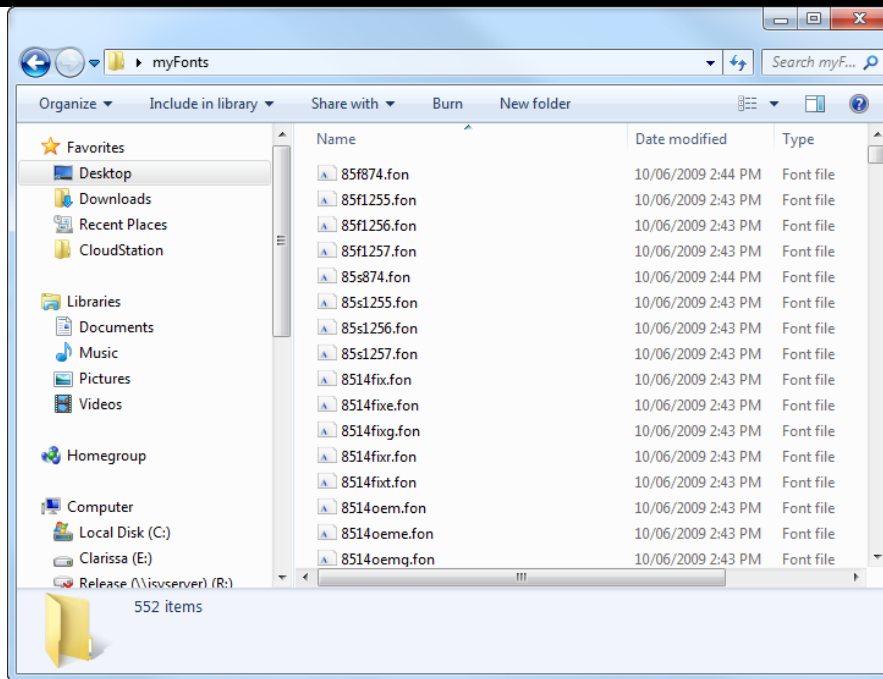

Create a new folder in a convenient location (e.g. a folder named myFonts on the Desktop), then press **Ctrl+V** to paste all of the fonts into this folder.

STEP 4 of 9

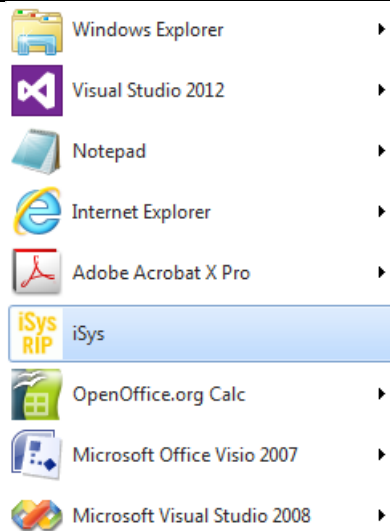

Open Windows Start and find **UniNet RIP**, click to open the software.

STEP 5 of 9

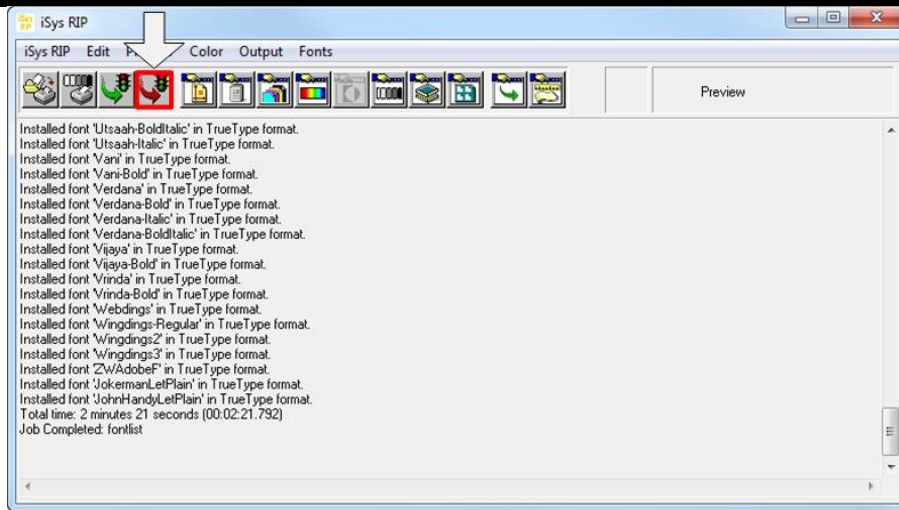

Click the **Red Stop Light Icon** to pause the program.

STEP 6 of 9

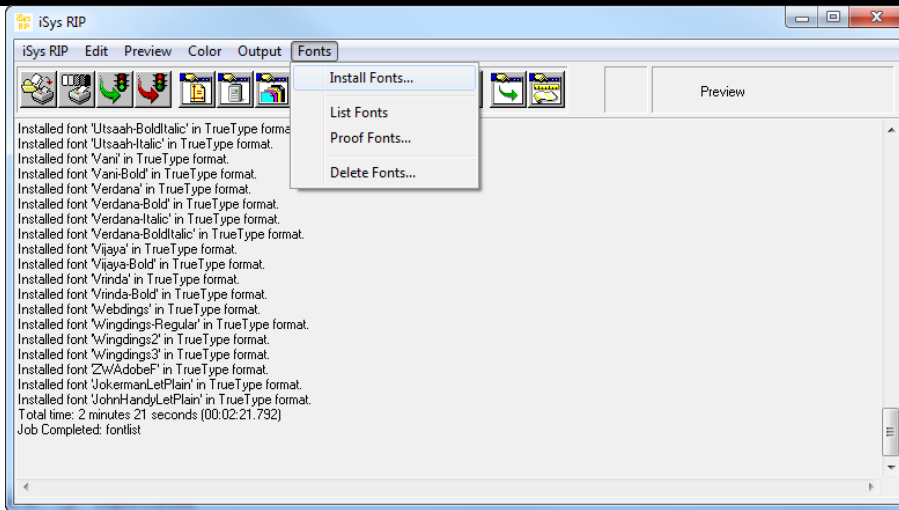

Click **Fonts**→**Install Fonts** from the toolbar.

STEP 7 of 9

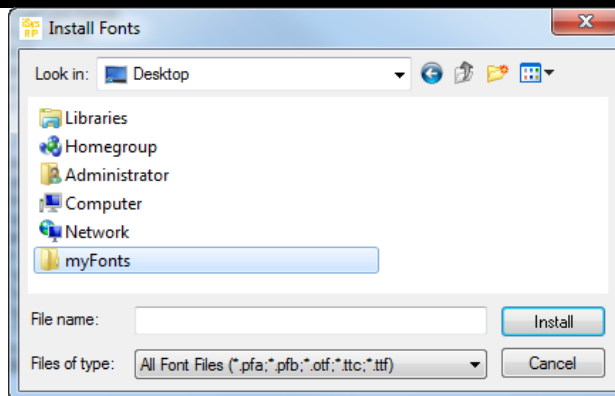

Find the new folder you just created which has all of the fonts. Double click to open.

STEP 8 of 9

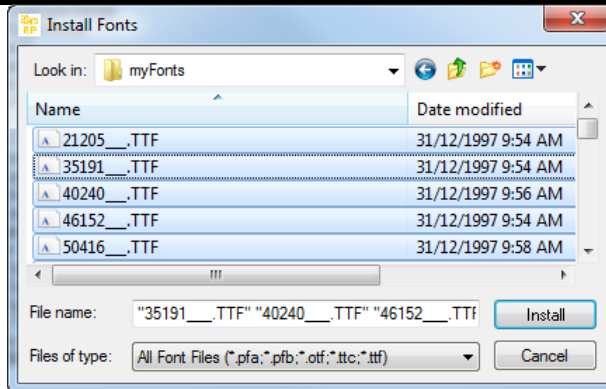

Press **Ctrl+A** to select all of the fonts, and click **Install**.

STEP 9 of 9

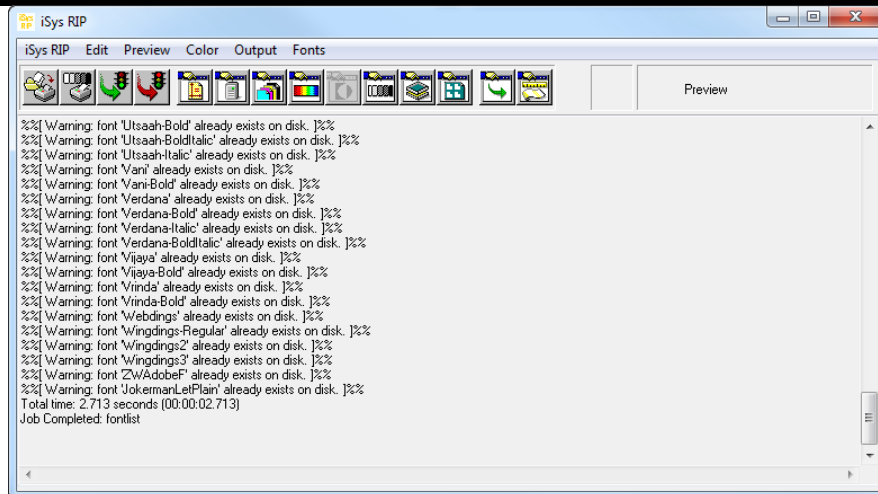

The fonts will start to install to the RIP. Once the job has been completed all of the fonts will be available in the EDGE2Print Software.

5.5 Rip Rotate Options

STEP 1 of 1

Rip Rotate Options

0 90 180 270 Rip Mirror



When the **Rip Rotate Option** is set to 0 all PDF files will preview in their original orientation. The Rip Rotate Options will allow for the desired orientation. For example, if you check 90 in the RIP Rotation Option, the image will rotate 90 degrees clockwise.

To rotate the graphic, first you will need to clear it from the EDGE2Print software, select the desired rotation, then re-import the graphic.

Adjustments can now be made in the Page Information Section for correct placement on the selected media.

NOTE: If the graphic does not fit the width of the media when rotated, a red error will show on the Image List.

5.6 Rip Scaling Options

STEP 1 of 1

Rip Scaling Options

X(width) 2.618 Y(height) 4.232



If the size of your image is not the same as the label size, you can use the RIP Scaling Option to adjust it. Input the width of label into **X(width)** and put the height of label into **Y(height)**.

Select the desired scaling values, then select **Clear** in the Image List section. Re-import the graphic into the EDGE2Print software. The Preview Screen will now show the graphic scaled according to your specifications.

NOTE: When scaling an image, some resolution may be lost and result in pixilation. If this is the case, consult your graphic designer and have them properly scale the image rather than using the Scaling feature.

5.7 Bounding Box Option

STEP 1 of 4

Selected Media
iSys new 

The software offers option to use different bounding box for your PDF file to print. First, select a user defined media, then click the colourful square.

STEP 2 of 4

RIP ColorPro Setup Form

Current Media Color Options

- Software Will Leave RIP Unadjusted
- Only Apply Linearization
- Apply ICC Profile with RIP Setup Options

Bounding Box

- MediaBox
- ArtBox
- BleedBox
- CropBox
- TrimBox

Save Cancel

On the right side, you will see the **Bounding Box** option. Select the bounding box you want to use and click **Save**. The default set is **MediaBox**.

STEP 3 of 4

EDGE2Print R2.2.0.5

File Media Nesting Variable Data Banner Cost Report Setup Options

Selected Media
121 

Open File

Die Cut Mode:
 Die Cut Mode:
 Cut On The Fly:

Page Information : Inches

Start Position: 0.000
Media Width: 6.500
Horizontal Shift (-/+): 0.000
Gutter: 0.125
Alley: 0.125

Print: 3.497 feet

Labels to Print: 10 Add Edit

Print

Image List

Remove	File Name	Toner Cost
Delete	Apex_Tapas(8.27x3.15)	0.06956

Clear

Rip Rotate Options

- 0
- 90
- 180
- 270

Rip Mirror

Rip Scaling Options

- X(width) 4.000
- Y(height) 6.000

Printer Settings

Printer Status: Ready To Print/Power Save

Page Count: 0



Then load your PDF and print your job. This is the PDF with **MediaBox**.

STEP 4 of 4

The screenshot displays the EDGE2Print R2.2.0.5 software interface. The top menu bar includes File, Media, Nesting, Variable Data, Banner, Cost Report, and Setup Options. The left sidebar contains the following sections:

- Selected Media:** 121, with an 'Open File' button and a color calibration icon.
- Die Cut Mode:** Die Cut Mode: Cut On The Fly:
- Page Information : Inches:** Start Position: 0.000, Media Width: 6.500, Horizontal Shift (-/+): 0.000, Gutter: 0.125, Alley: 0.125. An 'Apply' button is next to the Horizontal Shift field.
- Print:** Labels to Print: 10, with 'Add' and 'Edit' buttons, and a 'Print' button.
- Image List:** A large empty rectangular area with a 'Clear' button below it.
- Rip Rotate Options:** Radio buttons for 0, 90 (selected), 180, and 270 degrees. A Rip Mirror checkbox.
- Rip Scaling Options:** X(width) 4,000, Y(height) 6,000.
- Printer Settings:** Printer Status: Ready To Print/Power Save, Page Count: 0.

The main preview area shows two identical labels for 'tagas' brand 'CREMA DELICIOSA Oliv- & tomaterème'. Each label features a large illustration of a sliced tomato and olives. The text on the labels includes:

- Top left: 'tagas' logo in orange script.
- Below logo: 'CREMA DELICIOSA Oliv- & tomaterème' in white and yellow text.
- Bottom right: 'CREMA DELICIOSA' above a small image of the product and a '1000 g e' weight indicator.
- Bottom left: A barcode with the number '7 331010 093212'.
- Small text at the top: 'INGREDIENTES: Crema with aroma olive (15 %), Macerado de aceitunas, aceite de oliva, sal, levadura, estabilizante, gel de pectina.' and 'MATERIA PRIMA: 1000 g/35.27 oz'. Below this is a 'Barrido' section with fields for 'Producto', 'Lote', and 'Fecha'.
- Small text at the bottom: 'Original (Impresión) tamaño: 15x40 cm', 'Diseño: Edén, Impresión: C (0411) 160-40', 'www.druman.com', 'Impresión: Edén', 'Barrido: Edén', 'ANEXOS', 'Compu: Edén', 'Druvan' logo, and 'En stock por pedido por su favor. Contáctenos al teléfono: 1691. Cód. de pól. www.druman.com'.

This is the same PDF as the one above with TrimBox.

5.8 Saving and Loading Page Information

STEP 1 of 2

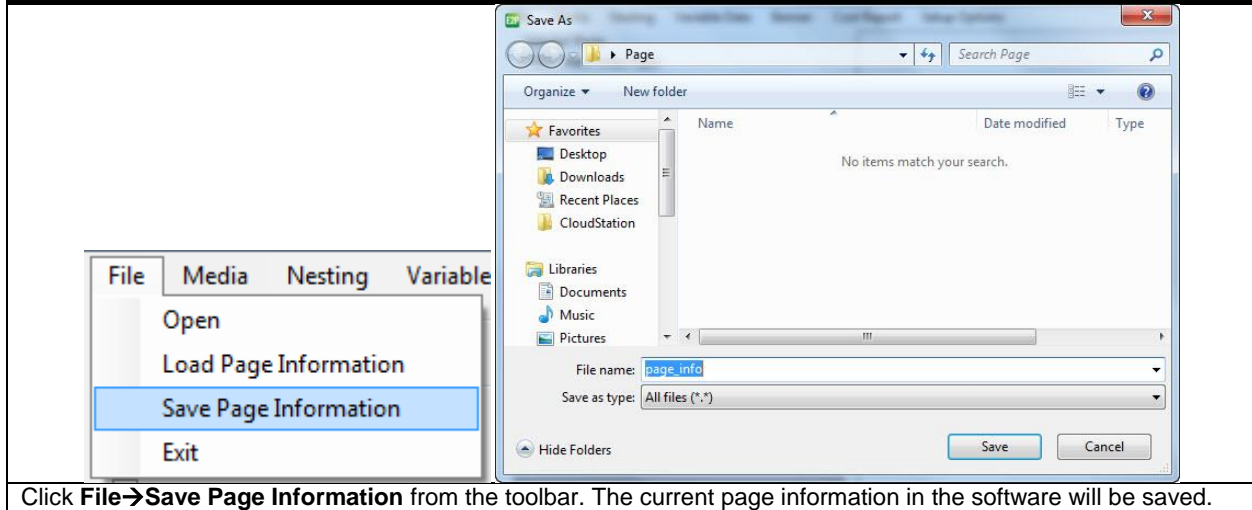

Click **File→Save Page Information** from the toolbar. The current page information in the software will be saved.

STEP 2 of 2

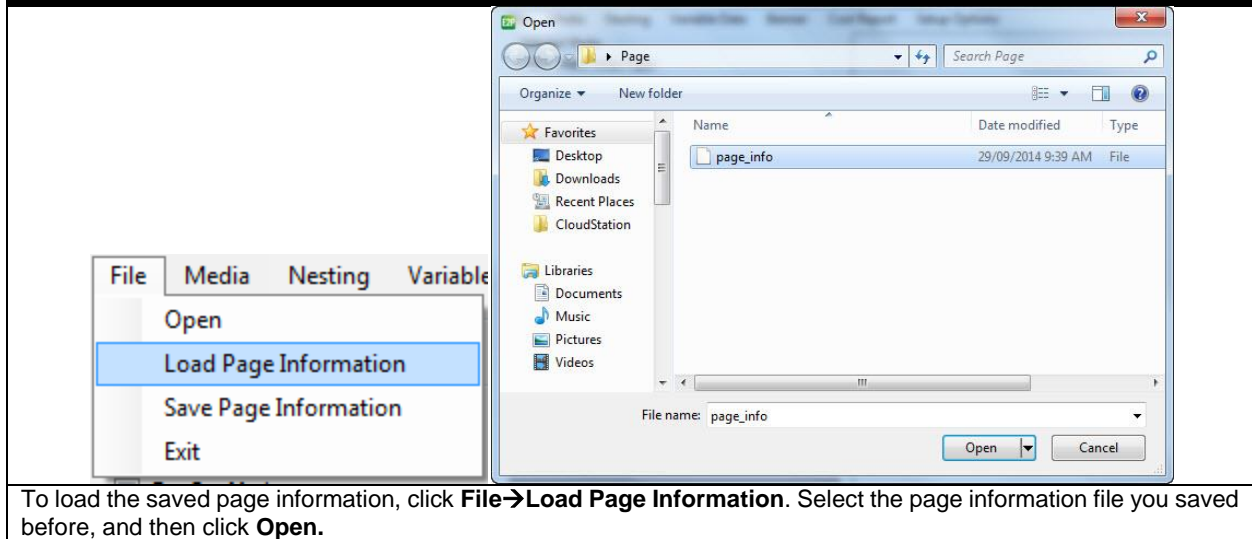

To load the saved page information, click **File→Load Page Information**. Select the page information file you saved before, and then click **Open**.

5.9 How to View Cost Estimation Report

From EDGE2Print toolbar click **Cost Report**. The Cost Estimation Report will be displayed within a text file. Notice that the 3 PDF files are in the job and each are separately calculated. The **TOTAL COST** of all jobs is calculated at the bottom of the page along with the **TOTAL LENGTH**. Actual costs can vary based on paper choice, color profile, media settings, as well as other factors.

STEP 1 of 3

File Media Nesting Variable Data Banner **Cost Report** Setup Options

To view cost report, click **Cost Report** from the toolbar.

STEP 2 of 3

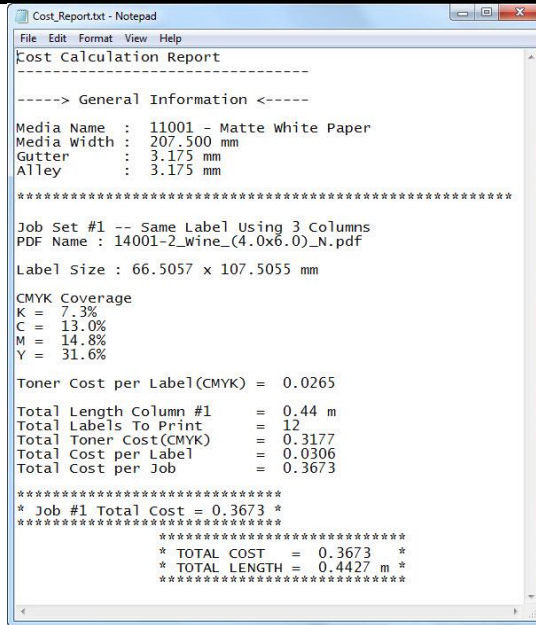

```
Cost_Report.txt - Notepad
File Edit Format View Help
Cost Calculation Report
-----
----> General Information <-----
Media Name : 11001 - Matte White Paper
Media Width : 207.500 mm
Gutter : 3.175 mm
Alley : 3.175 mm
*****

Job Set #1 -- Same Label Using 3 Columns
PDF Name : 14001-2_Wine_(4.0x6.0)_N.pdf
Label Size : 66.5057 x 107.5055 mm

CMYK Coverage
K = 7.3%
C = 13.0%
M = 14.8%
Y = 31.6%

Toner Cost per Label(CMYK) = 0.0265

Total Length Column #1 = 0.44 m
Total Labels To Print = 12
Total Toner Cost(CMYK) = 0.3177
Total Cost per Label = 0.0306
Total Cost per Job = 0.3673

*****
* Job #1 Total Cost = 0.3673 *
*****
* TOTAL COST = 0.3673 *
* TOTAL LENGTH = 0.4427 m *
*****
```

The following window will pop up. This is the cost estimation report for the last printing job.

There are three different types of job estimation given:

Total Toner Cost = This is the cost estimate of toner ONLY

Total Cost Per Label = This takes into account the wear and tear on the drums, transfer belt and fuser. It also adds in the cost of the media based on the length of material used.

Total Cost Per Job = This is the total estimated cost for the amount of labels you selected to be printed, including the toner, drums, transfer belt, fuser and media.

STEP 3 of 3

The screenshot displays a software interface with a menu bar at the top: File, Media, Nesting, Variable Data, Banner, Cost Report, and Options. The 'Options' menu is open, showing sub-menus for Printer, Software, and Preferences. The 'Software' sub-menu is further open, listing Cost Calculator, Display Options, Print Alignment, Variable Data (highlighted), and White Toner. In the background, the 'Variable Data' menu item is visible, and the 'Selected Media' field shows '11001 - Matte White Paper'. Below the menu, there are checkboxes for 'Die Cut Mode:' and 'Cut On The Fly:'. A 'Variable Data Setup' dialog box is open in the foreground, containing the following settings:

- Dongle ID: 18
- Printer Output Processing:
 - Always Vertically Processing
 - Always Horizontal Processing
 - Always Ask
- Layout Display Processing:
 - Display Vertical (Longer Processing)
 - Display Horizontal
- Printing Options:
 - Pause Before Printing
 - Pause Between 1.9 GB Print Jobs
 - Generate Cost Report After Printing

For variable data printing, you can select the above to generate cost estimation report after printing.

5.10 Reprint Option

STEP 1 of 5

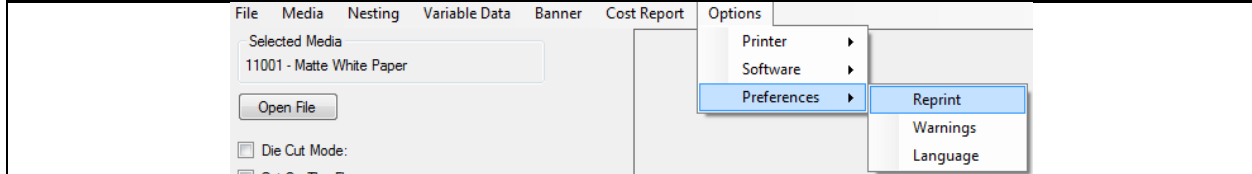

Click **Options->Preferences->Reprint** from the toolbar.

STEP 2 of 5

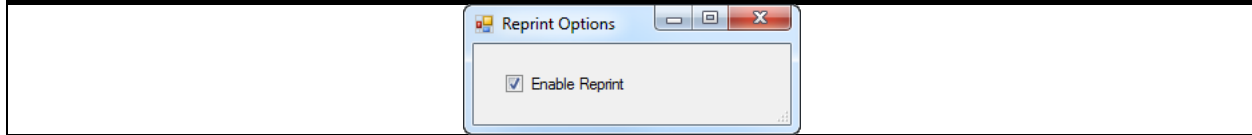

Check the box. This will enable the reprint option.

STEP 3 of 5

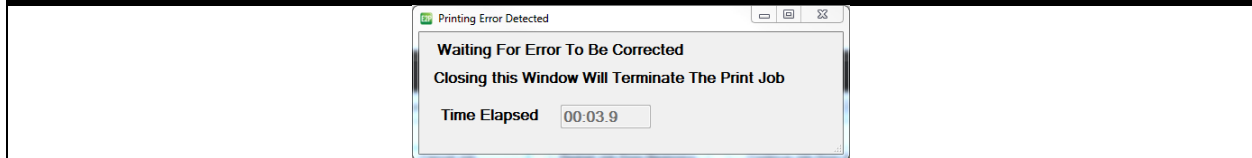

If an error occurs, the error window will appear. Leave the window untouched.

STEP 4 of 5



Go to your printer and feeder, correct the error, make the printer showing **Ready to Print** and feeder showing **Status: Idle**. (When the printer asks to **Continue** or **Cancel**, press **CANCEL** button.)

STEP 5 of 5

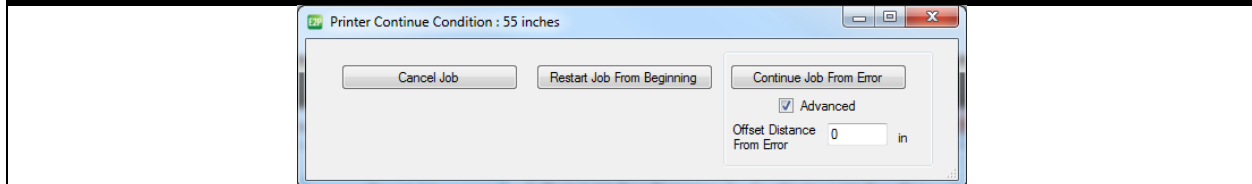

After the machine is recovered, turn back to the software, you have options to **Cancel Job**, **Restart Job from Beginning** or **Continue Job from Error**. Choose one from the window above. If you choose to continue job from error, you have an advanced option to determine the offset distance from error.

5.11 Warning Options

5.11.1 Consumable Warning

STEP 1 of 3

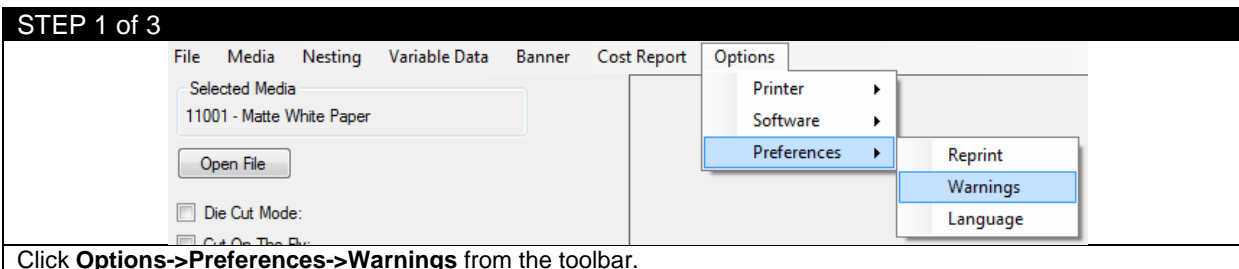

The screenshot shows a software interface with a menu bar containing 'File', 'Media', 'Nesting', 'Variable Data', 'Banner', 'Cost Report', and 'Options'. The 'Options' menu is open, showing 'Printer', 'Software', and 'Preferences'. The 'Preferences' sub-menu is also open, showing 'Reprint', 'Warnings', and 'Language'. The 'Warnings' option is highlighted. In the background, the 'Selected Media' field shows '11001 - Matte White Paper' and there is an 'Open File' button.

Click **Options->Preferences->Warnings** from the toolbar.

STEP 2 of 3

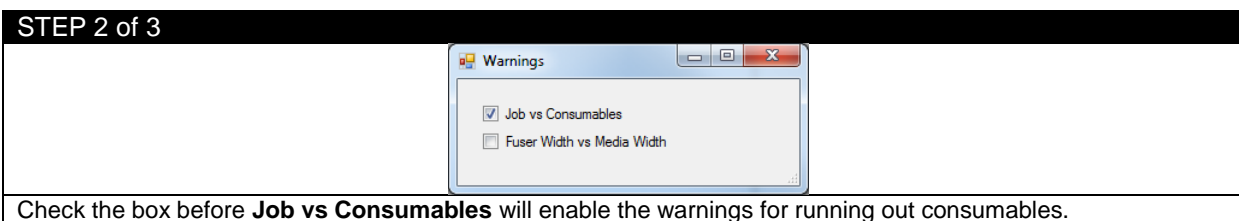

The screenshot shows a 'Warnings' dialog box with two checkboxes: 'Job vs Consumables' (checked) and 'Fuser Width vs Media Width' (unchecked).

Check the box before **Job vs Consumables** will enable the warnings for running out consumables.

STEP 3 of 3

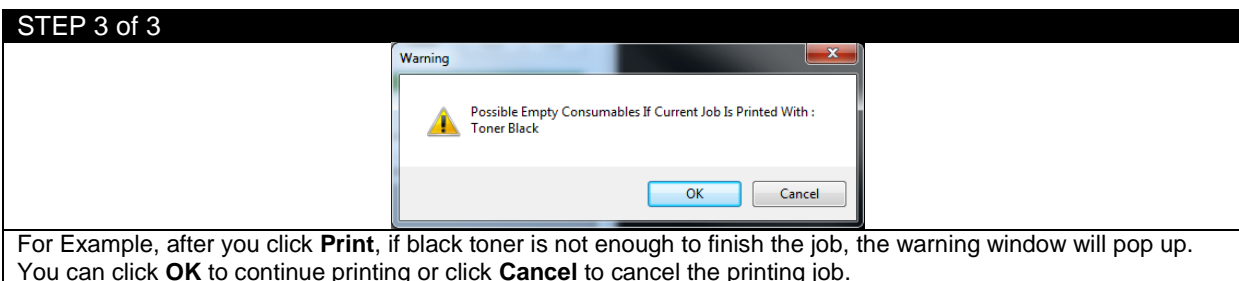

The screenshot shows a 'Warning' dialog box with a yellow warning icon and the text: 'Possible Empty Consumables If Current Job Is Printed With : Toner Black'. There are 'OK' and 'Cancel' buttons at the bottom.

For Example, after you click **Print**, if black toner is not enough to finish the job, the warning window will pop up. You can click **OK** to continue printing or click **Cancel** to cancel the printing job.

5.11.2 Fuser Warning

STEP 1 of 3

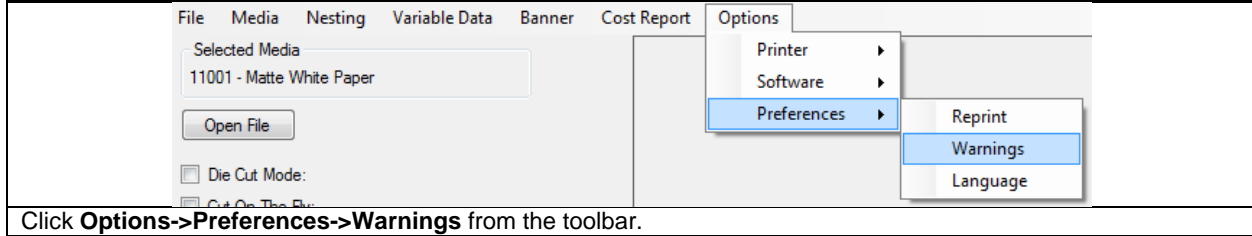

Click **Options->Preferences->Warnings** from the toolbar.

STEP 2 of 3

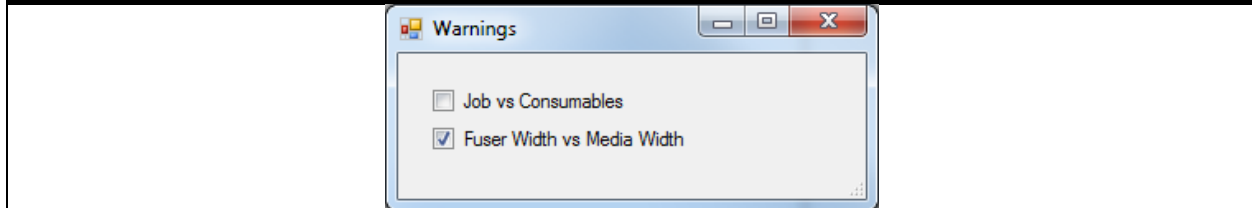

Check the box before **Fuser Width vs Media Width** will enable the warning of the fuser width according to the media width.

STEP 3 of 3

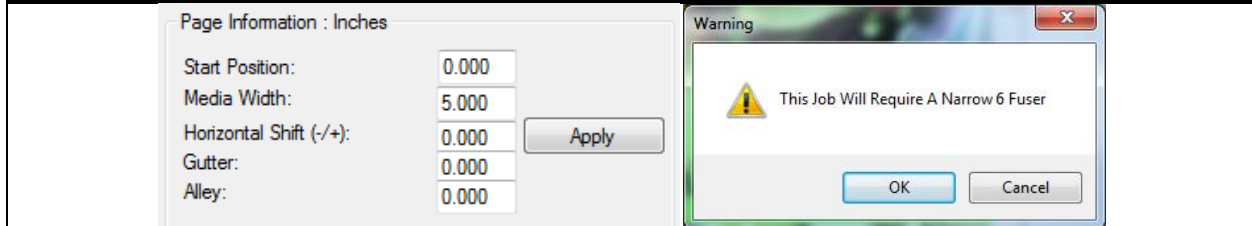

For example, after you click **Print**, the warning window will pop up to let you know the correct size of fuser should be used according to the Media Width you input in **Page Information**. You can click **OK** to continue printing or click **Cancel** to cancel the printing job.

NOTE: This warning window will pop up every time if it's enabled.

5.12 White Toner Warning

STEP 1 of 3

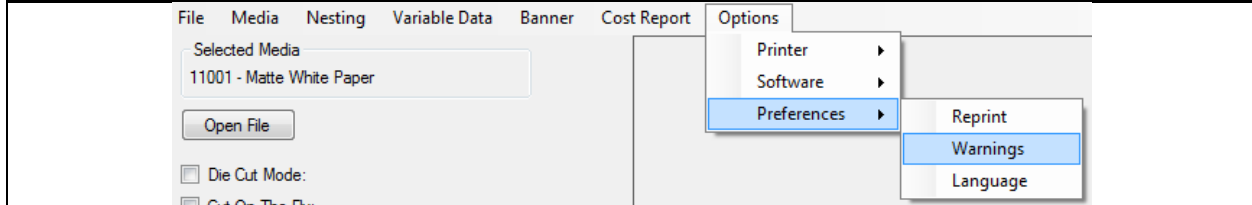

If you have white toner license activated, you can turn on/off the white toner warning. Click Options->Preferences->Warnings from the toolbar.

STEP 2 of 3

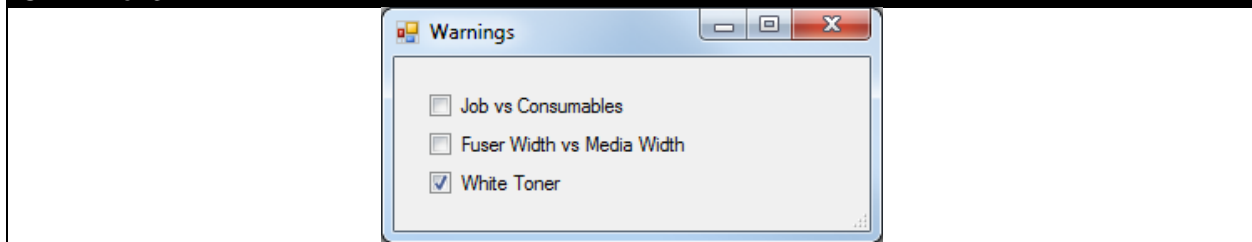

Check the box before **White Toner** will enable the warning of the White toner cartridge before printing.

STEP 3 of 3

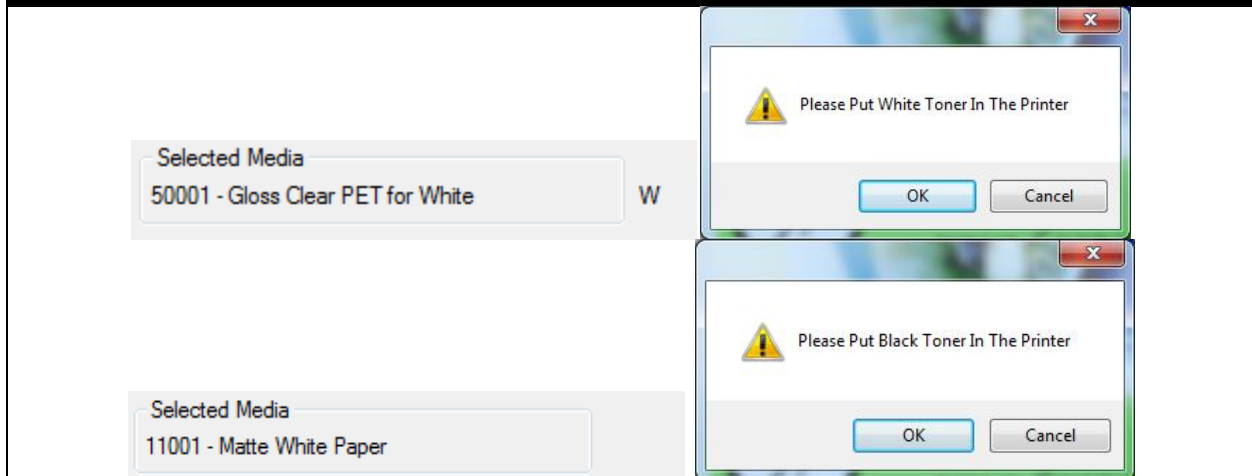

If you select media for white toner, the warning to put white toner in the printer will pop up. If you select media other than white toner, the warning to put black toner in the printer will pop up.

6 Trouble Shooting and Maintenance

6.1 Toner Cartridge Replacement

STEP 1 of 8

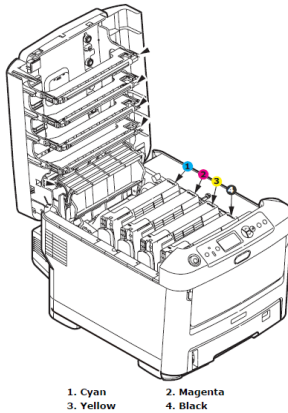

Press the cover release and open the printer's top cover fully. Note the position of the four cartridges.

STEP 2 of 8

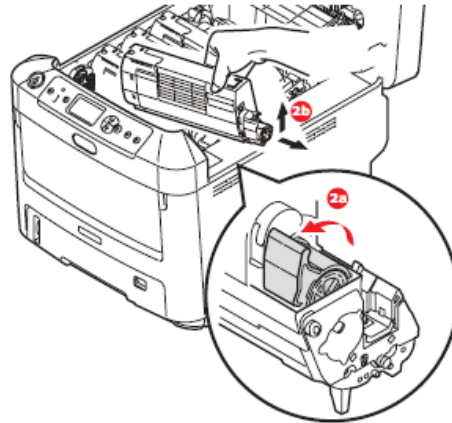

- (a) Pull the colored toner release lever on the cartridge to be replaced fully towards the front of the printer.
- (b) Lift the right hand end of the cartridge and then draw the cartridge to the right to release the left hand end as shown, and withdraw the toner cartridge out of the printer.

STEP 3 of 8

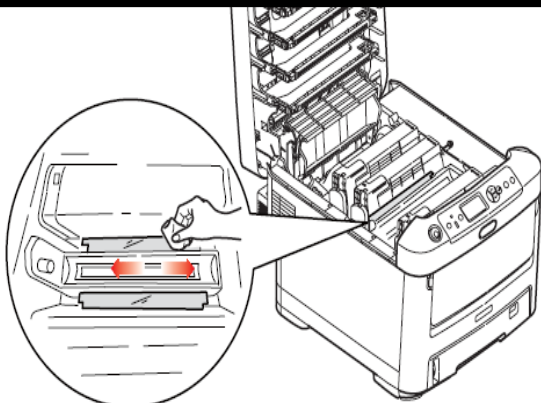

Clean the top of the ID unit with a clean, lint free cloth. Remove the new cartridge from its box but leave its wrapping material in place.

STEP 4 of 8

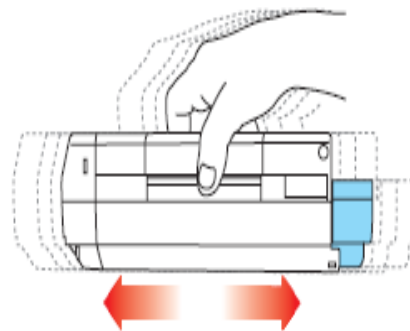

Gently shake the new cartridge from end to end several times to loosen and distribute the toner evenly inside the cartridge.

STEP 5 of 8

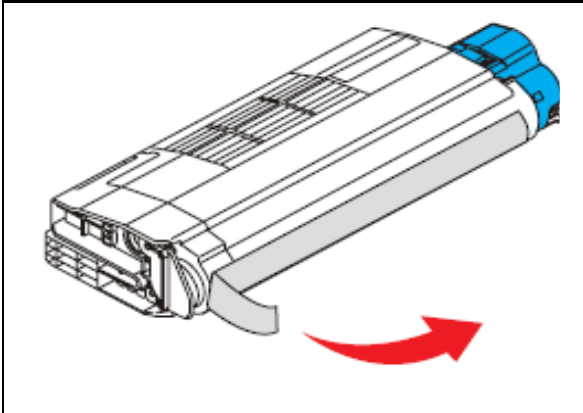

Remove the wrapping material and peel off the adhesive tape from the underside of the cartridge.

STEP 6 of 8

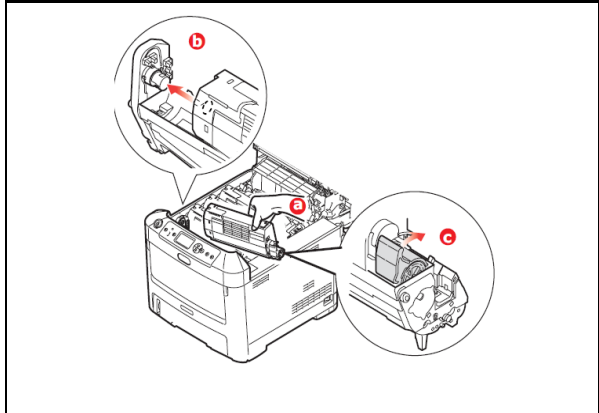

Insert the left end of the cartridge into the top of the image drum unit first; pushing it against the spring on the drum unit, then lower the right end of the cartridge down onto the image drum unit.

STEP 7 of 8

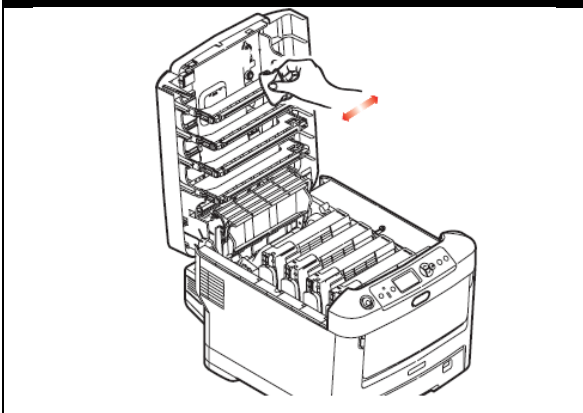

Pressing gently down on the cartridge to ensure that it is firmly seated, push the colored lever towards the rear of the printer. This will lock the cartridge into place and release toner into the image drum unit.

Gently wipe the LED head surface with a clean, lint free cloth.

STEP 8 of 8

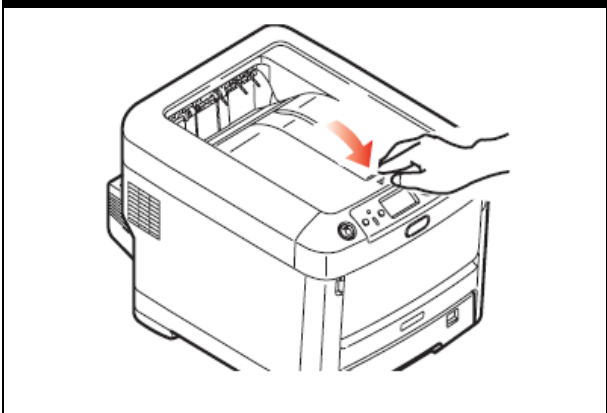

Finally close the top cover and press down firmly at both sides so that the cover latches closed.

6.2 Image Drum Replacement

The printer contains four image drums: cyan, magenta, yellow and black.

CAUTION! Static sensitive devices, handle with care.

STEP 1 of 8

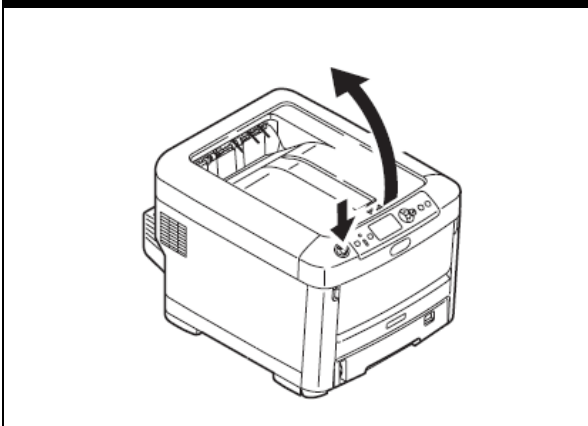

Press the cover release and open the printer's top cover fully.

STEP 2 of 8

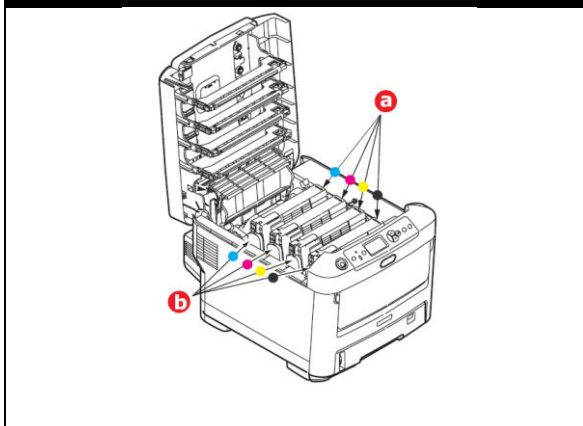

Note the position of the four toner cartridges (a) and image drums (b) it is essential that they go back in the same order.

WARNING! If the printer has been powered on, the fuser will be hot. Do not touch.

CAUTION! The green image drum surface at the base of the ID unit is very delicate and light sensitive. Do not touch it and do not expose it to normal room light for more than 5 minutes. If the drum unit needs to be out of the printer for longer than this, please wrap the cartridge inside a black plastic bag to keep it away from light. Never expose the drum to direct sunlight or very bright room lighting.

STEP 3 of 8

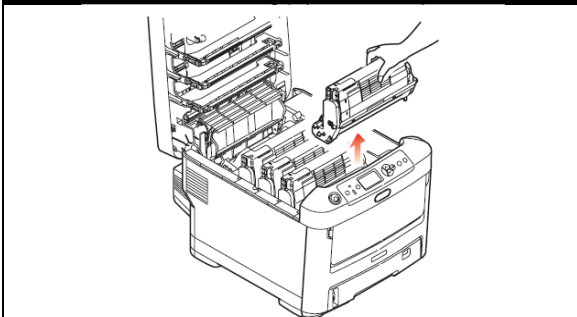

Holding it by its top center, lift the image drum, complete with its toner cartridge, up and out of the printer.

STEP 4 of 8

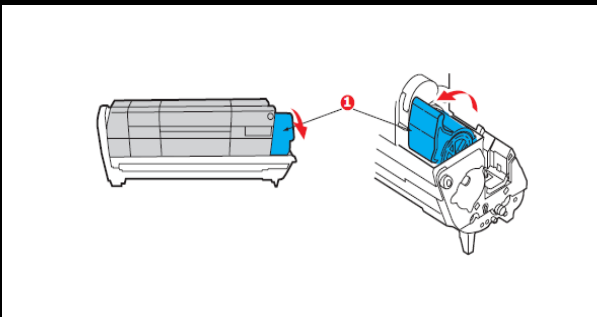

With the colored toner release lever (1) to the right, pull the lever towards you. This will release the toner cartridge from the drum.

STEP 5 of 8

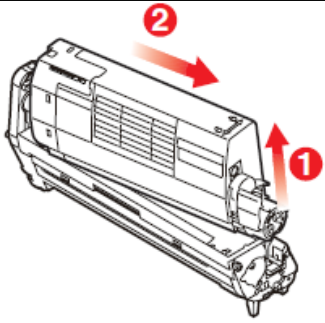

Lift the right hand end of the toner cartridge (1) and then draw the cartridge to the right to release the left-hand end as shown (2) and withdraw the toner cartridge out of the image drum cartridge. Place the cartridge on a piece of paper to avoid marking your furniture.

STEP 6 of 8

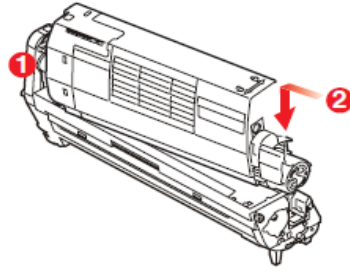

Place the toner cartridge onto the new image drum cartridge as shown. Push the left end in first and then lower the right end in. (It is not necessary to fit a new toner cartridge at this time unless the remaining toner level is very low.)

STEP 7 of 8

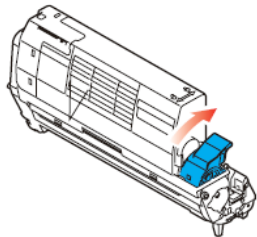

Push the colored release lever away from you to lock the toner cartridge onto the new image drum unit and release toner into it.

STEP 8 of 8

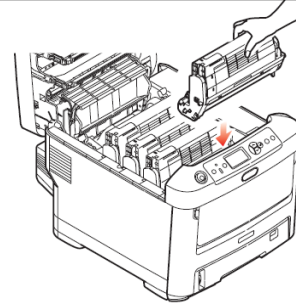

Holding the complete assembly by its top center, lower it into place in the printer, locating the pins at each end into their slots in the sides of the printer.

6.3 Replacing the Transfer Belt Unit

The transfer belt unit is located under the four image drums. Switch off the printer and allow the fuser to cool for about 10 minutes before opening the cover.

STEP 1 of 6

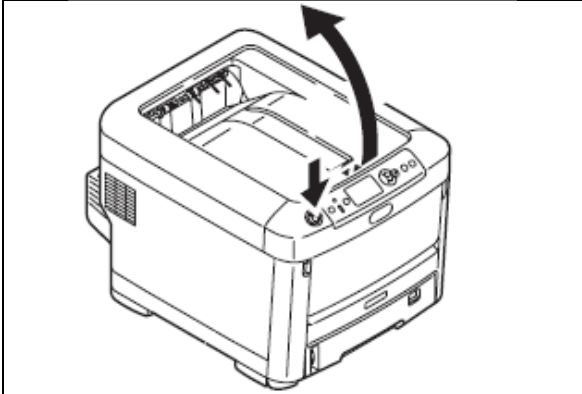

Press the cover release and open the printer's top cover fully.

STEP 2 of 6

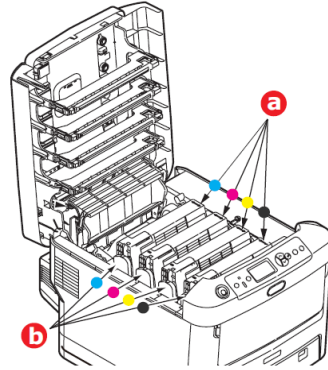

Note the positions of the four toner cartridges (a) and image drums (b) it is essential that they go back in the same order.

STEP 3 of 6

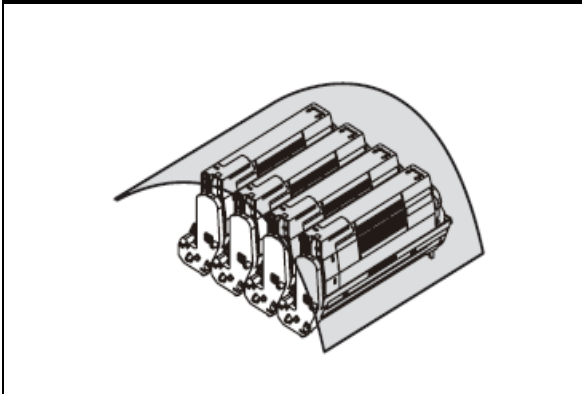

Lift each of the image drum units out of the printer and place them in a safe place away from direct sources of heat and light.

STEP 4 of 6

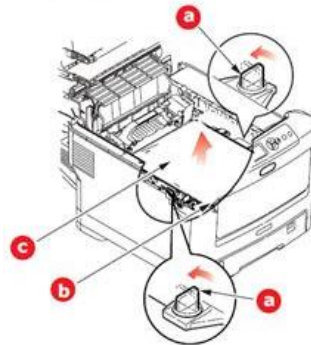

Locate the two fasteners (a) at each side of the belt and the lifting bar (b) at the front end. Turn the two fasteners 90° to the left. This will release the belt from the printer chassis. Pull the lifting bar (b) upwards so that the belt tilts up towards the front, and withdraw the belt unit (c) from the printer.

CAUTION! The green image drum surface at the base of the ID unit is very delicate and light sensitive. Do not touch it and do not expose it to normal room light for more than 5 minutes. If the drum unit needs to be out of the printer for longer than this, please wrap the cartridge inside a black plastic bag to keep it away from light. Never expose the drum to direct sunlight or very bright room lighting.

STEP 5 of 6

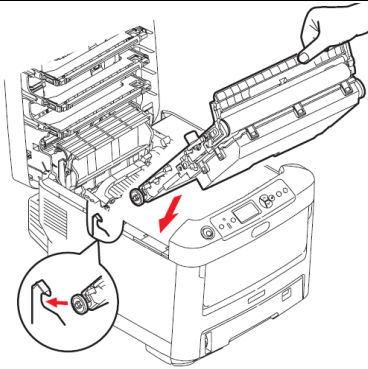

Lower the new belt unit into place, with the lifting bar at the front and the drive gear towards the rear of the printer. Locate the drive gear into the gear inside the printer by the rear left corner of the unit, and lower the belt unit flat inside the printer.

STEP 6 of 6

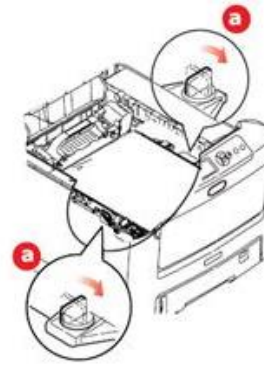

Turn the two fasteners (a) 90° to the right until they lock. This will secure the belt unit into place. Replace the four image drums, complete with their toner cartridges, into the printer in the same sequence as they came out.

Close the top cover and press down firmly at both sides so that the cover latches closed.

6.4 Fuser Replacement

The fuser is located inside the printer just behind the four image drum units.

WARNING! If the printer has recently been powered on, some fuser components will be very hot. Handle the fuser with extreme care, holding it only by its handle, which will only be mildly warm to touch. A warning label clearly indicates the area. If in doubt, switch the printer off and wait at least 10 minutes for the fuser to cool before opening the printer cover.

STEP 1 of 5

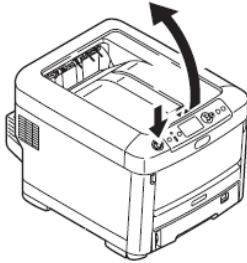

Press the cover release and open the printer's top cover fully.

STEP 2 of 5

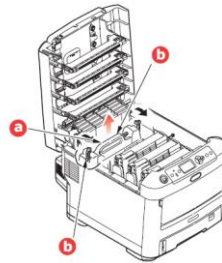

Identify the fuser handle (a). Pull the two fuser retaining levers (b) towards the front of the printer so that they are fully upright. Remove the new fuser from its packaging and remove the transit material.

STEP 3 of 5

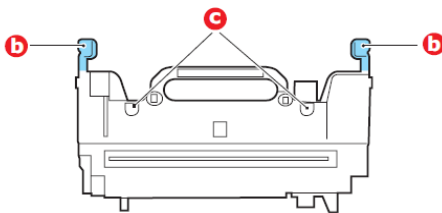

Holding the new fuser by its handle, make sure that it is the correct way round. The retaining levers (b) should be fully upright, and the two locating lugs (c) should be towards you.

STEP 4 of 5

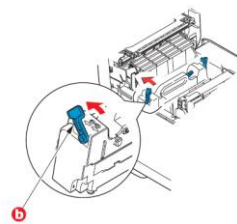

Lower the fuser into the printer, locating the two lugs in the slots in the metal partition which separates the fuser from the image drums. Push the two retaining levers (b) towards the rear of the printer to lock the fuser in place.

STEP 5 of 5

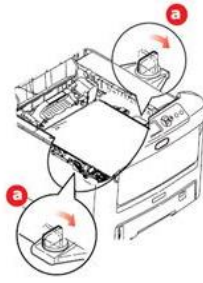

Place the drums back into the printer and replace the lid.

6.5 Clearing Paper Jams

STEP 1 of 17



Press the cover release and open the top cover.

STEP 2 of 17

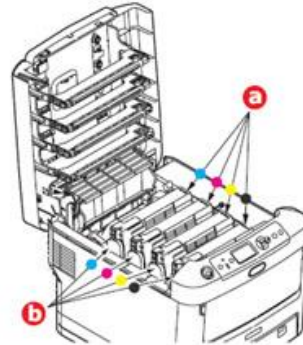

Note the position of the four toners cartridges (a) and image drums (b). It is essential that they go back in the same order.

STEP 3 of 17

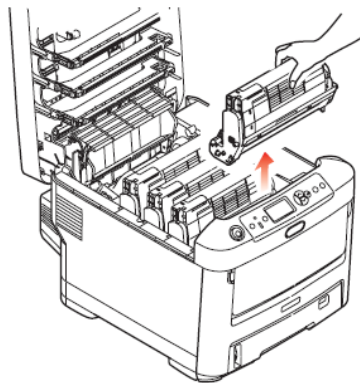

Lift the image drum, complete with its toner cartridge, up and out of the printer

STEP 4 of 17

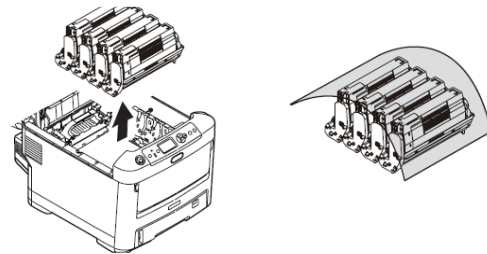

Put the assembly down gently onto a piece of paper to prevent toner from staining surrounding areas and to avoid damaging the green drum surface and cover.

CAUTION: The green image drum surface at the base of the Image Drum is very delicate and light sensitive. Do not touch it and do not expose it to normal room light for more than 5 minutes. If the drum unit needs to be out of the printer for longer than this, wrap the cartridge inside a black plastic bag to keep it away from light. Never expose the drum to direct sunlight or very bright room lighting.

STEP 5 of 17

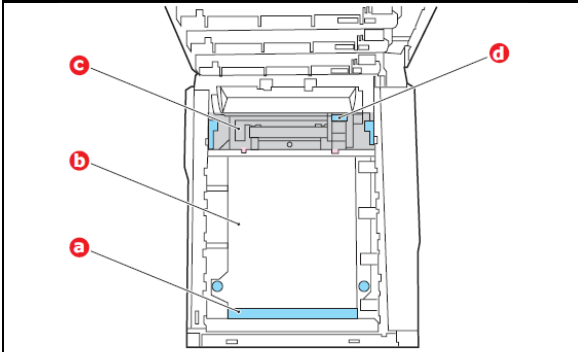

Check if any sheets of paper are visible on any part of the belt unit (a. release handle, b. belt, c. fuser or d. fuser pressure release lever).

STEP 6 of 17

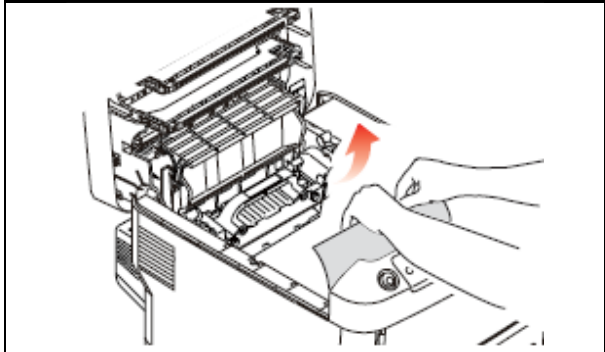

To remove sheet from the front, lift the sheet from the belt and pull it forward into the internal drum cavity to withdraw the sheet.

STEP 7 of 17

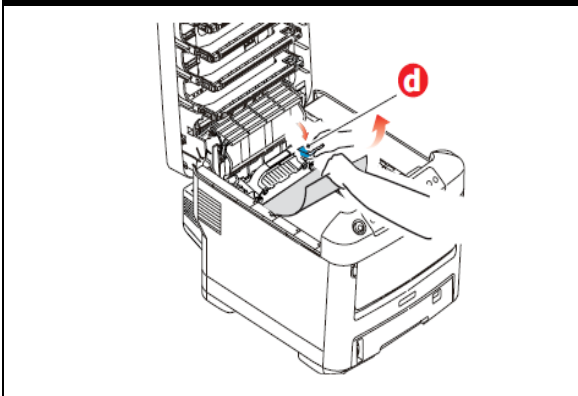

To remove a sheet from the central area, separate the sheet from the belt surface and withdraw the sheet.

STEP 8 of 17

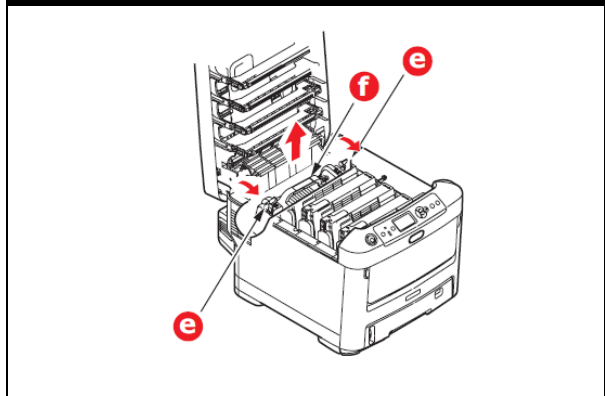

To remove a sheet in the fuser; push the two retaining levers (e) towards the rear of the printer to release the fuser. Withdraw the fuser unit using the handle (f).

STEP 9 of 17

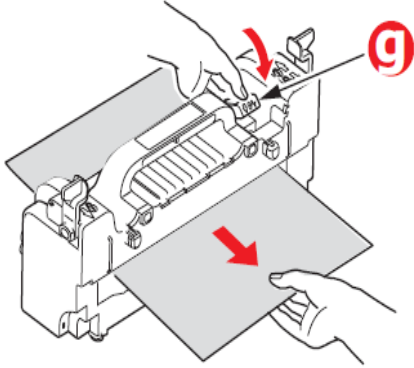

Press release lever (g) and pull trapped paper from the fuser.

STEP 10 of 17

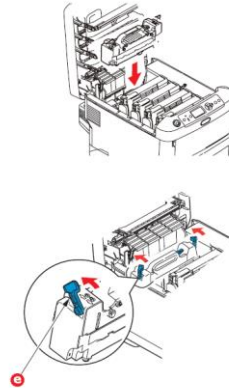

Replace fuser unit into the machine and move locking levers (e) toward the rear of the machine.

STEP 11 of 17

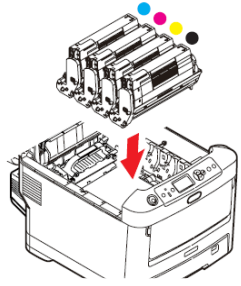

Starting with the cyan image drum unit nearest the fuser, replace the four image drums into the drum cavity, making sure to place in the correct order.

STEP 12 of 17

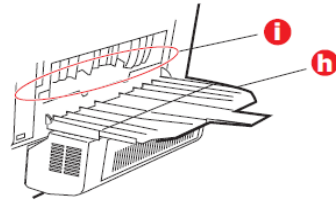

Open the rear exit tray (h) and check for sheets of paper in the rear path area (i), pull out any sheets found in this area.

STEP 13 of 17

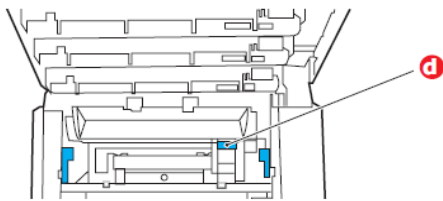

If the sheet is low down in this area and difficult to remove, it is probably still gripped by the fuser. In this case raise the top cover, reach around and press down on the fuser pressure release lever (d).

STEP 14 of 17

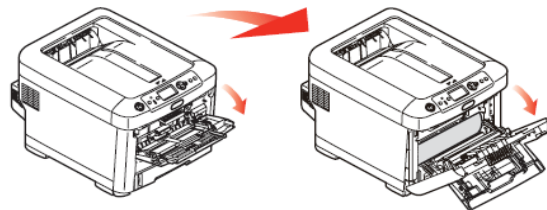

Pull down the MP tray using the depressions. Lift the front cover release lever and lower the front cover.

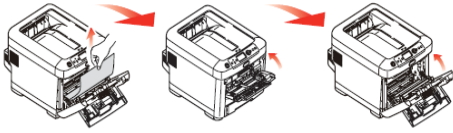
STEP 15 of 17

Check inside the cover for sheets in this area and remove any that you find, and then close the cover.

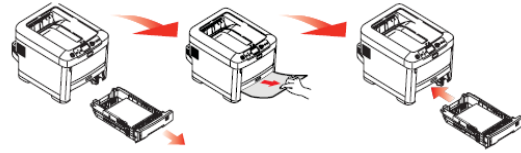
STEP 16 of 17

Pull out the paper tray and ensure all paper is stacked properly, is undamaged, and that the paper guides are properly positioned against the edge of the paper stack. When satisfied replace the tray. Close the top cover and press down firmly so the cover latch closes.

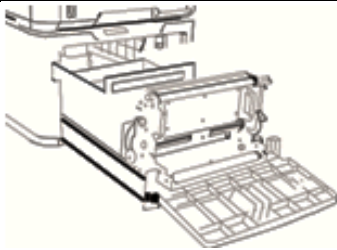
STEP 17 of 17

Pull out the paper guide tray, clear out any paper jams. Reload fan fold paper and close the paper guide tray.

The following table summarizes possible causes of paper jams and suggests ways of avoiding them.

POSSIBLE CAUSE	SUGGESTED REMEDY
The printer is not level.	Place the printer on a steady, level surface.
Your print media is too light or too heavy.	Use appropriate media
Your print media is damp or charged with static electricity.	Use media that has been stored in appropriate temperature and humidity conditions.
Your print media is creased or curled.	Use appropriate media. Decurled media can be used.
Your print media sheets are not aligned with each other.	Remove the sheets, jog them into alignment and reload them.
Your print media is not aligned properly in the paper tray.	Adjust the paper stop and paper guides of the tray, or the manual feed guide on the MP Tray to align the media properly.

6.6 How to Print Configuration Information from the Printer

STEP 1 of 1

1. Press **DOWN** arrow, scroll to **Print Information**, press **Enter**.
2. Select **Configuration**, press **Enter**.
3. Select **Execute**. It will then start to print the page information.

6.7 How to Print a Secure Job from the Printer

STEP 1 of 1

1. Press **DOWN** arrow, scroll to **Print Secure Job**, press **Enter**.
2. Select **Stored Job**, press **Enter**.
3. At this step, you have 4 passwords (0000,0001,0002,0003) for the different jobs.
 - 0000 is for drum test
 - 0001 is for color test
 - 0002 is for die-cut test (you should use die-cut media for this job)
 - 0003 is for calibration. (It is the same as **Color Registration** from the Software)
4. Press **Enter** after your key in the password.
5. Select **Print**.
4. Choose the amount of copies you want to print, and press **Enter**.

6.8 Sensor Calibration from the Feeder (For Die Cut Labels Only)

STEP 1 of 11



Follow STEP 1-7 of "Loading Media for Continuous Printing" to load the roll. Place the roll of paper into the paper tray. Feed the media through, ensuring it is underneath the tension and pinch rollers. With the media flush against the back of the machine, ensure that there is no extra space on each side of the media and the left/right media guides.

Close the left/right media guides. Ensure that the media is not buckling or too snug against the guide widths before proceeding.

STEP 2 of 11

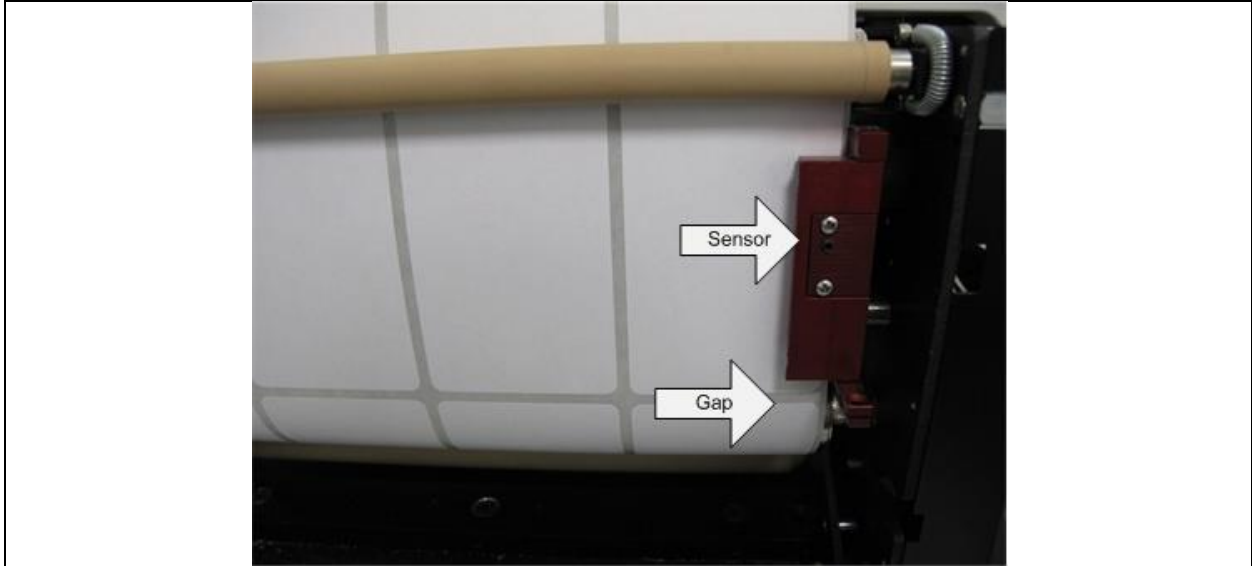

Line up the gap of the labels about one inch below the sensor.

STEP 3 of 11

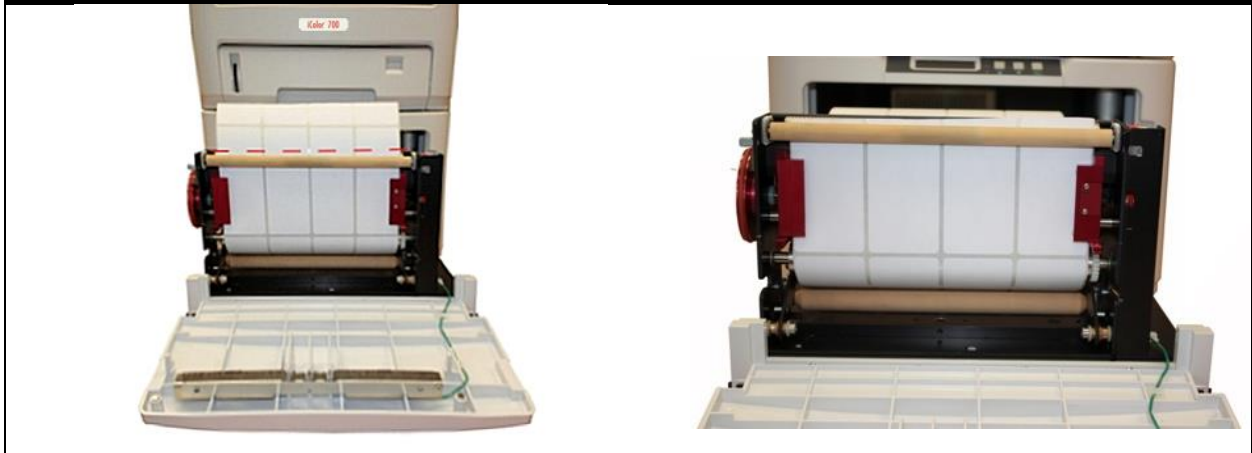

Cut the excess paper to make sure the top of paper is flush with the drive roller.

Backwind the roll to ensure there is no tension when the sensor is calibrating. If the roll is fully wound and has tension on it, it will skew the calibration.

STEP 4 of 11



Press the **On Line** button to take the feeder offline.

STEP 5 of 11

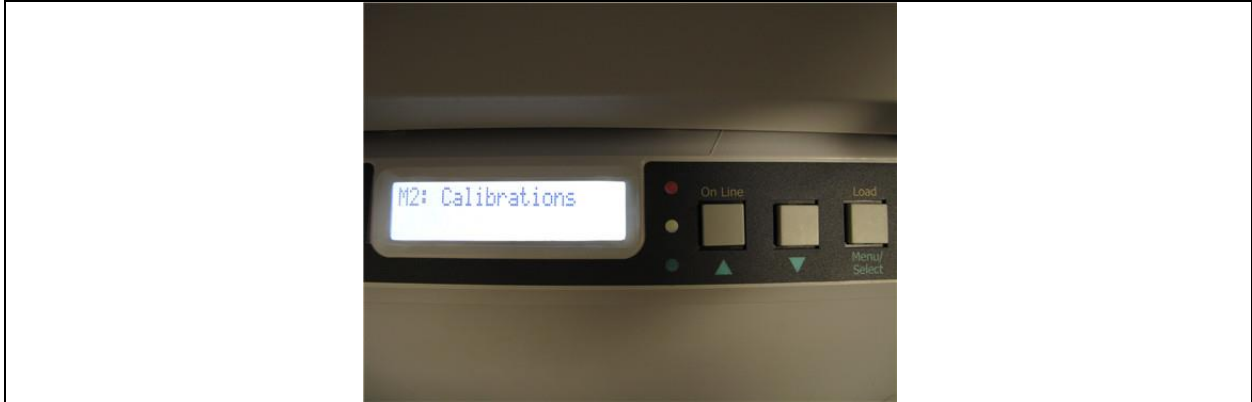

Press **Menu** twice to get to **M2: Calibrations**.

STEP 6 of 11



Press the **UP** arrow button to get to **I3: Reg Sensor**. Hold down the **Menu** button until the * disappears. Press **Menu** twice to get to the sensor type. Use the **UP** and/or **DOWN** buttons to set the Gap. Then hold **Menu** until it stops flashing.

STEP 7 of 11



Press the **UP** arrow to scroll to **I4: RSEN AutoCal** and hold **Menu** until **Ready** starts flashing.
Press the **UP** arrow to select **Execute** and hold **Menu** until it stops flashing.

STEP 8 of 11



Press **Menu** again and it will show **Status: Offline**.

STEP 9 of 11



Press the **On Line** button and the calibration test will begin. After the calibration is done, it will read **Status: Require Load**.

STEP 10 of 11



After the calibration process, press the **On Line** button to turn the machine **Offline**, and then hold the **DOWN** button to cut the excess paper after the calibration is complete.

NOTE: If you press **Load** at this moment, the machine might show **Path Full** because of the excess paper.



Remove the paper. Press the **On Line** button again and select **Load**. After this, the machine will show **Idle** and is ready to use now that the calibration is done.

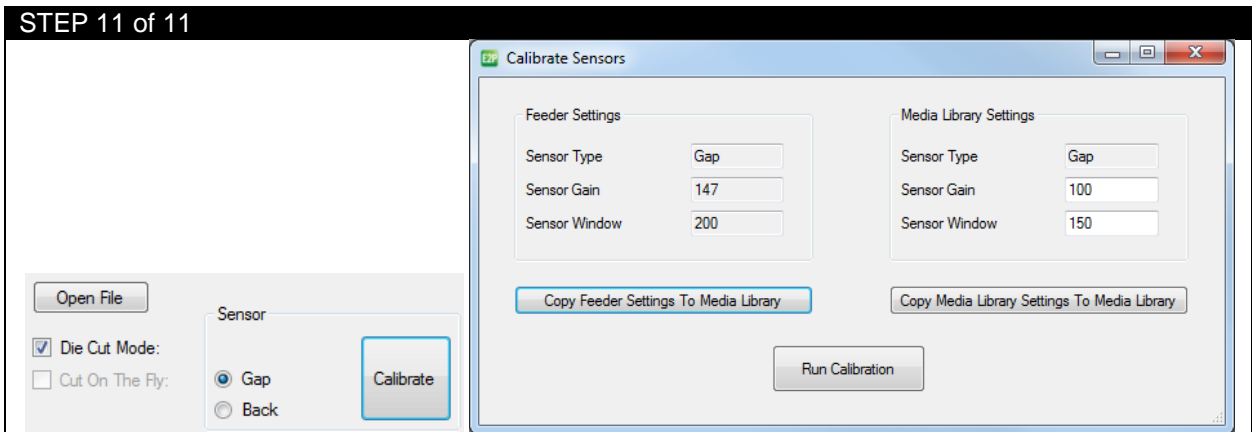

Go the EDGE2Print software, click **Calibrate** and then click **Copy Feeder Setting To Media Library** to save the setting. Or when you print, the values in the media library will overwrite the values in the feeder.

6.9 How to Access the Settings as an Administrator

You can set whether to **ENABLE** or **DISABLE** each category in the user menu.

Disabled categories are not displayed in the User's menu. Only a system administrator can change these settings.

1. Turn **OFF** the printer. Turn **ON** the printer while pressing the **Enter** button. When **Boot Menu** appears, take your finger off the button.
2. Press the **Enter** button.
3. At the Enter Password prompt, enter the 4-9 digit Admin password. **(The default password is aaaaaa).**
 - (a) Using the up and down MENU buttons, scroll to the required letter/digit.
 - (b) Press the Enter button to input and move to the next letter/digit.
 - (c) Repeat steps (a) and (b) until all letters/digits are entered.
4. Press the **Enter** button.
5. Press the **UP or DOWN arrow** button until the "category" you want to change is displayed.
6. Press the **Enter** button.
7. Press the **UP or DOWN arrow** button until the "item" you want to change is displayed.
8. Press the **Enter** button.
9. Using the **UP or DOWN arrow** button, identify the parameter as required.
10. Press the **Enter** button to enter an asterisk (*) on the right side of the setting selected.
11. Press the **Online** button to switch to online. The machine will automatically re-boot.

6.10 Paper Sensor Error Codes

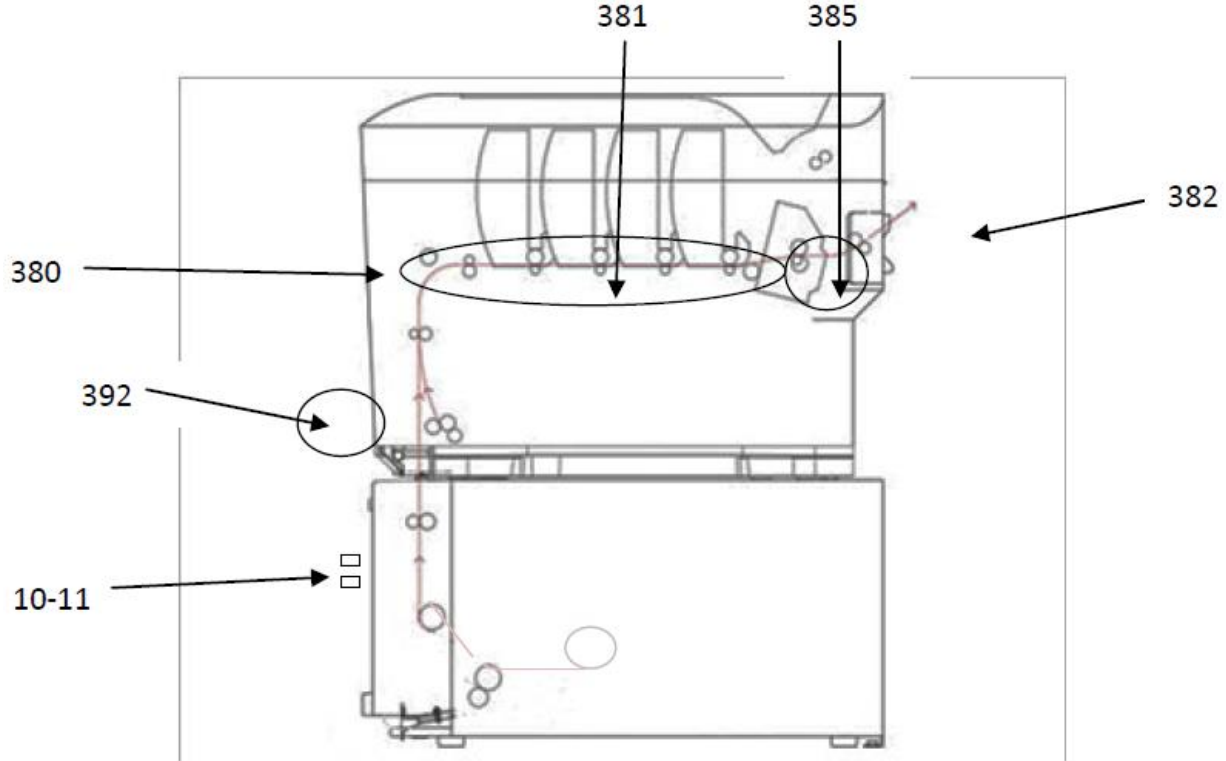

Code #	Location
380	Paper Feed Upper
381	Paper Transport
382	Paper Exit
385	Fuser
392	Paper Feed Lower
10 - 11	Load Sensors

Feeder Panel Error Messages:

Message	Issue
Msg: Guide Door Open	Ensure Guide Door is Closed
Msg: Guide Tray Out	Push Guide Tray Completely into the Feeder. Ensure Guide Tray Latches are Locked.
Msg: Close Guide Tray	Ensure Guide Door is Closed
Msg: Close Door/Tray	Push Guide Tray Completely into the Feeder. Ensure Guide Tray Latches are Locked.
Msg: Funnel Full	Remove all Paper from the Guide.
Msg: Path Full	Remove all Paper from the Guide.

Feeder Panel Errors:

Error	Issue	Solution
Status: Error 00	Emergency stop (guide door opened during motor movement)	Close Door on Feeder
Status: Error 01	Switch panel communication error	Contact your dealer/reseller
Status: Error 02	Internal error	Contact your dealer/reseller
Status: Error 03	Internal error	Contact your dealer/reseller
Status: Error 10	Media not found over lower load sensor after load	Do a sensor calibration(p.57 in the manual) or remove paper in path
Status: Error 11	Media not positioned between load sensors properly after load advance	Check that media tension is not too tight
Status: Error 31	Cutter did not leave home position in required time	Check paper jam in cutter
Status: Error 32	Cutter did not finish cut in required time or can't home it	Check paper jam in cutter

For further information, please visit the support page at www.icolorprint.com/support

Technical Support Email: support@icolorprint.com

Technical Support Phone: 631-590-1040, Option 2